

Dimensions and weights . . . . .	<b>REF•1</b>	Radio/cassette unit anti-theft system - precaution . . . . .	<b>REF•7</b>
Conversion factors . . . . .	<b>REF•2</b>	Tools and working facilities . . . . .	<b>REF•8</b>
Buying spare parts . . . . .	<b>REF•3</b>	MOT test checks . . . . .	<b>REF•10</b>
General repair procedures . . . . .	<b>REF•4</b>	Fault finding . . . . .	<b>REF•14</b>
Vehicle identification numbers . . . . .	<b>REF•5</b>	Glossary of technical terms . . . . .	<b>REF•24</b>
Jacking and vehicle support . . . . .	<b>REF•6</b>	Index . . . . .	<b>REF•29</b>



## Dimensions and weights

**Note:** All figures are approximate, and may vary according to model. Refer to manufacturer's data for exact figures.

### Dimensions

Overall length:	
Including spare wheel . . . . .	4538 mm
Including tow hitch . . . . .	4581 mm
Overall width . . . . .	2189 mm
Overall height (unladen) . . . . .	1914 mm

### Weights

Kerb weight:	<b>3-door</b>	<b>5-door</b>
Petrol engine models:		
Carburettor engine . . . . .	1979 kg	-
Fuel injection engine . . . . .	2089 kg	2128 kg
200 TDi engine models . . . . .	2008 kg	2053 kg
300 TDi engine models . . . . .	2040 kg	2065 kg
Maximum gross vehicle weight (all models) . . . . .	2720 kg	
Maximum roof rack load:		
On-road . . . . .	50 kg	
Off-road . . . . .	30 kg	
Maximum trailer nose weight . . . . .	75 kg	
Maximum towing weight:		
Unbraked trailer:		
On-road . . . . .	750 kg	
Off-road . . . . .	500 kg	
Trailer with overrun brakes:		
On-road . . . . .	3500 kg	
Off-road . . . . .	1000 kg	

# REF•2 Conversion factors

## Length (distance)

Inches (in)	x 25.4 = Millimetres (mm)	x 0.0394 = Inches (in)
Feet (ft)	x 0.305 = Metres (m)	x 3.281 = Feet (ft)
Miles	x 1.609 = Kilometres (km)	x 0.621 = Miles

## Volume (capacity)

Cubic inches (cu in; in <sup>3</sup> )	x 16.387 = Cubic centimetres (cc; cm <sup>3</sup> )	x 0.061 = Cubic inches (cu in; in <sup>3</sup> )
Imperial pints (Imp pt)	x 0.568 = Litres (l)	x 1.76 = Imperial pints (Imp pt)
Imperial quarts (Imp qt)	x 1.137 = Litres (l)	x 0.88 = Imperial quarts (Imp qt)
Imperial quarts (Imp qt)	x 1.201 = US quarts (US qt)	x 0.833 = Imperial quarts (Imp qt)
US quarts (US qt)	x 0.946 = Litres (l)	x 1.057 = US quarts (US qt)
Imperial gallons (Imp gal)	x 4.546 = Litres (l)	x 0.22 = Imperial gallons (Imp gal)
Imperial gallons (Imp gal)	x 1.201 = US gallons (US gal)	x 0.833 = Imperial gallons (Imp gal)
US gallons (US gal)	x 3.785 = Litres (l)	x 0.264 = US gallons (US gal)

## Mass (weight)

Ounces (oz)	x 28.35 = Grams (g)	x 0.035 = Ounces (oz)
Pounds (lb)	x 0.454 = Kilograms (kg)	x 2.205 = Pounds (lb)

## Force

Ounces-force (ozf; oz)	x 0.278 = Newtons (N)	x 3.6 = Ounces-force (ozf; oz)
Pounds-force (lbf; lb)	x 4.448 = Newtons (N)	x 0.225 = Pounds-force (lbf; lb)
Newtons (N)	x 0.1 = Kilograms-force (kgf; kg)	x 9.81 = Newtons (N)

## Pressure

Pounds-force per square inch (psi; lbf/in <sup>2</sup> ; lb/in <sup>2</sup> )	x 0.070 = Kilograms-force per square centimetre (kgf/cm <sup>2</sup> ; kg/cm <sup>2</sup> )	x 14.223 = Pounds-force per square inch (psi; lbf/in <sup>2</sup> ; lb/in <sup>2</sup> )
Pounds-force per square inch (psi; lbf/in <sup>2</sup> ; lb/in <sup>2</sup> )	x 0.068 = Atmospheres (atm)	x 14.696 = Pounds-force per square inch (psi; lbf/in <sup>2</sup> ; lb/in <sup>2</sup> )
Pounds-force per square inch (psi; lbf/in <sup>2</sup> ; lb/in <sup>2</sup> )	x 0.069 = Bars	x 14.5 = Pounds-force per square inch (psi; lbf/in <sup>2</sup> ; lb/in <sup>2</sup> )
Pounds-force per square inch (psi; lbf/in <sup>2</sup> ; lb/in <sup>2</sup> )	x 6.895 = Kilopascals (kPa)	x 0.145 = Pounds-force per square inch (psi; lbf/in <sup>2</sup> ; lb/in <sup>2</sup> )
Kilopascals (kPa)	x 0.01 = Kilograms-force per square centimetre (kgf/cm <sup>2</sup> ; kg/cm <sup>2</sup> )	x 98.1 = Kilopascals (kPa)
Millibar (mbar)	x 100 = Pascals (Pa)	x 0.01 = Millibar (mbar)
Millibar (mbar)	x 0.0145 = Pounds-force per square inch (psi; lbf/in <sup>2</sup> ; lb/in <sup>2</sup> )	x 68.947 = Millibar (mbar)
Millibar (mbar)	x 0.75 = Millimetres of mercury (mmHg)	x 1.333 = Millibar (mbar)
Millibar (mbar)	x 0.401 = Inches of water (inH <sub>2</sub> O)	x 2.491 = Millibar (mbar)
Millimetres of mercury (mmHg)	x 0.535 = Inches of water (inH <sub>2</sub> O)	x 1.868 = Millimetres of mercury (mmHg)
Inches of water (inH <sub>2</sub> O)	x 0.036 = Pounds-force per square inch (psi; lbf/in <sup>2</sup> ; lb/in <sup>2</sup> )	x 27.68 = Inches of water (inH <sub>2</sub> O)

## Torque (moment of force)

Pounds-force inches (lbf in; lb in)	x 1.152 = Kilograms-force centimetre (kgf cm; kg cm)	x 0.868 = Pounds-force inches (lbf in; lb in)
Pounds-force inches (lbf in; lb in)	x 0.113 = Newton metres (Nm)	x 8.85 = Pounds-force inches (lbf in; lb in)
Pounds-force inches (lbf in; lb in)	x 0.083 = Pounds-force feet (lbf ft; lb ft)	x 12 = Pounds-force inches (lbf in; lb in)
Pounds-force feet (lbf ft; lb ft)	x 0.138 = Kilograms-force metres (kgf m; kg m)	x 7.233 = Pounds-force feet (lbf ft; lb ft)
Pounds-force feet (lbf ft; lb ft)	x 1.356 = Newton metres (Nm)	x 0.738 = Pounds-force feet (lbf ft; lb ft)
Newton metres (Nm)	x 0.102 = Kilograms-force metres (kgf m; kg m)	x 9.804 = Newton metres (Nm)

## Power

Horsepower (hp)	x 745.7 = Watts (W)	x 0.0013 = Horsepower (hp)
-----------------	---------------------	----------------------------

## Velocity (speed)

Miles per hour (miles/hr; mph)	x 1.609 = Kilometres per hour (km/hr; kph)	x 0.621 = Miles per hour (miles/hr; mph)
--------------------------------	--	--

## Fuel consumption\*

Miles per gallon, Imperial (mpg)	x 0.354 = Kilometres per litre (km/l)	x 2.825 = Miles per gallon, Imperial (mpg)
Miles per gallon, US (mpg)	x 0.425 = Kilometres per litre (km/l)	x 2.352 = Miles per gallon, US (mpg)

## Temperature

Degrees Fahrenheit = (°C x 1.8) + 32                      Degrees Celsius (Degrees Centigrade; °C) = (°F - 32) x 0.56

\* It is common practice to convert from miles per gallon (mpg) to litres/100 kilometres (l/100km), where mpg x l/100 km = 282

Spare parts are available from many sources, including maker's appointed garages, accessory shops, and motor factors. To be sure of obtaining the correct parts, it may sometimes be necessary to quote the vehicle identification number. If possible, it can also be useful to take the old parts along for positive identification. Items such as starter motors and alternators may be available under a service exchange scheme - any parts returned should always be clean.

Our advice regarding spare part sources is as follows.

**Officially-appointed garages**

This is the best source of parts which are peculiar to your vehicle, and are not otherwise generally available (eg badges, interior trim, certain body panels, etc). It is also the only place at which you should buy parts if the vehicle is still under warranty.

**Accessory shops**

These are very good places to buy materials and components needed for the maintenance of your vehicle (oil, air and fuel filters, spark plugs, light bulbs, drivebelts, oils and greases, brake pads, touch-up paint, etc). Parts like this sold by a reputable shop are of the same standard as those used by the vehicle manufacturer.

**Motor factors**

Good factors will stock all the more important components which wear out comparatively quickly and can sometimes supply individual components needed for the overhaul of a larger assembly. They may also handle work such as cylinder block reboring, crankshaft regrinding and balancing, etc.

**Tyre and exhaust specialists**

These outlets may be independent or members of a local or national chain. They

frequently offer competitive prices when compared with a main dealer or local garage, but it will pay to obtain several quotes before making a decision. Also ask what 'extras' may be added to the quote - for instance, fitting a new valve and balancing the wheel are both often charged on top of the price of a new tyre.

**Other sources**

Beware of parts or materials obtained from market stalls, car boot sales or similar outlets. Such items are not invariably sub-standard, but there is little chance of compensation if they do prove unsatisfactory. In the case of safety-critical components such as brake pads, there is the risk not only of financial loss, but also of an accident causing injury or death.

Second-hand components or assemblies obtained from a car breaker can be a good buy in some circumstances, but this sort of purchase is best made by the experienced DIY mechanic.

Whenever servicing, repair or overhaul work is carried out on the car or its components, observe the following procedures and instructions. This will assist in carrying out the operation efficiently and to a professional standard of workmanship.

### Joint mating faces and gaskets

When separating components at their mating faces, never insert screwdrivers or similar implements into the joint between the faces in order to prise them apart. This can cause severe damage which results in oil leaks, coolant leaks, etc upon reassembly. Separation is usually achieved by tapping along the joint with a soft-faced hammer in order to break the seal. However, note that this method may not be suitable where dowels are used for component location.

Where a gasket is used between the mating faces of two components, a new one must be fitted on reassembly; fit it dry unless otherwise stated in the repair procedure. Make sure that the mating faces are clean and dry, with all traces of old gasket removed. When cleaning a joint face, use a tool which is unlikely to score or damage the face, and remove any burrs or nicks with an oilstone or fine file.

Make sure that tapped holes are cleaned with a pipe cleaner, and keep them free of jointing compound, if this is being used, unless specifically instructed otherwise.

Ensure that all orifices, channels or pipes are clear, and blow through them, preferably using compressed air.

### Oil seals

Oil seals can be removed by levering them out with a wide flat-bladed screwdriver or similar implement. Alternatively, a number of self-tapping screws may be screwed into the seal, and these used as a purchase for pliers or some similar device in order to pull the seal free.

Whenever an oil seal is removed from its working location, either individually or as part of an assembly, it should be renewed.

The very fine sealing lip of the seal is easily damaged, and will not seal if the surface it contacts is not completely clean and free from scratches, nicks or grooves. If the original sealing surface of the component cannot be restored, and the manufacturer has not made provision for slight relocation of the seal relative to the sealing surface, the component should be renewed.

Protect the lips of the seal from any surface which may damage them in the course of fitting. Use tape or a conical sleeve where possible. Lubricate the seal lips with oil before fitting and, on dual-lipped seals, fill the space between the lips with grease.

Unless otherwise stated, oil seals must be fitted with their sealing lips toward the lubricant to be sealed.

Use a tubular drift or block of wood of the appropriate size to install the seal and, if the seal housing is shouldered, drive the seal down to the shoulder. If the seal housing is

unshouldered, the seal should be fitted with its face flush with the housing top face (unless otherwise instructed).

### Screw threads and fastenings

Seized nuts, bolts and screws are quite a common occurrence where corrosion has set in, and the use of penetrating oil or releasing fluid will often overcome this problem if the offending item is soaked for a while before attempting to release it. The use of an impact driver may also provide a means of releasing such stubborn fastening devices, when used in conjunction with the appropriate screwdriver bit or socket. If none of these methods works, it may be necessary to resort to the careful application of heat, or the use of a hacksaw or nut splitter device.

Studs are usually removed by locking two nuts together on the threaded part, and then using a spanner on the lower nut to unscrew the stud. Studs or bolts which have broken off below the surface of the component in which they are mounted can sometimes be removed using a stud extractor. Always ensure that a blind tapped hole is completely free from oil, grease, water or other fluid before installing the bolt or stud. Failure to do this could cause the housing to crack due to the hydraulic action of the bolt or stud as it is screwed in.

When tightening a castellated nut to accept a split pin, tighten the nut to the specified torque, where applicable, and then tighten further to the next split pin hole. Never slacken the nut to align the split pin hole, unless stated in the repair procedure.

When checking or retightening a nut or bolt to a specified torque setting, slacken the nut or bolt by a quarter of a turn, and then retighten to the specified setting. However, this should not be attempted where angular tightening has been used.

For some screw fastenings, notably cylinder head bolts or nuts, torque wrench settings are no longer specified for the latter stages of tightening, "angle-tightening" being called up instead. Typically, a fairly low torque wrench setting will be applied to the bolts/nuts in the correct sequence, followed by one or more stages of tightening through specified angles.

### Locknuts, locktabs and washers

Any fastening which will rotate against a component or housing during tightening should always have a washer between it and the relevant component or housing.

Spring or split washers should always be renewed when they are used to lock a critical component such as a big-end bearing retaining bolt or nut. Locktabs which are folded over to retain a nut or bolt should always be renewed.

Self-locking nuts can be re-used in non-critical areas, providing resistance can be felt when the locking portion passes over the bolt or stud thread. However, it should be noted that self-locking stiffnuts tend to lose their

effectiveness after long periods of use, and should then be renewed as a matter of course.

Split pins must always be replaced with new ones of the correct size for the hole.

When thread-locking compound is found on the threads of a fastener which is to be re-used, it should be cleaned off with a wire brush and solvent, and fresh compound applied on reassembly.

### Special tools

Some repair procedures in this manual entail the use of special tools such as a press, two or three-legged pullers, spring compressors, etc. Wherever possible, suitable readily-available alternatives to the manufacturer's special tools are described, and are shown in use. In some instances, where no alternative is possible, it has been necessary to resort to the use of a manufacturer's tool, and this has been done for reasons of safety as well as the efficient completion of the repair operation. Unless you are highly-skilled and have a thorough understanding of the procedures described, never attempt to bypass the use of any special tool when the procedure described specifies its use. Not only is there a very great risk of personal injury, but expensive damage could be caused to the components involved.

### Environmental considerations

When disposing of used engine oil, brake fluid, antifreeze, etc, give due consideration to any detrimental environmental effects. Do not, for instance, pour any of the above liquids down drains into the general sewage system, or onto the ground to soak away. Many local council refuse tips provide a facility for waste oil disposal, as do some garages. If none of these facilities are available, consult your local Environmental Health Department, or the National Rivers Authority, for further advice.

With the universal tightening-up of legislation regarding the emission of environmentally-harmful substances from motor vehicles, most vehicles have tamperproof devices fitted to the main adjustment points of the fuel system. These devices are primarily designed to prevent unqualified persons from adjusting the fuel/air mixture, with the chance of a consequent increase in toxic emissions. If such devices are found during servicing or overhaul, they should, wherever possible, be renewed or refitted in accordance with the manufacturer's requirements or current legislation.



OIL BANK LINE  
0800 66 33 66  
www.oilbankline.org.uk

**Note: It is antisocial and illegal to dump oil down the drain. To find the location of your local oil recycling bank, call this number free.**

Modifications are a continuing and unpublicised process in vehicle manufacture, quite apart from major model changes. Spare parts manuals and lists are compiled upon a numerical basis, the individual vehicle

identification numbers being essential to correct identification of the component concerned.

When ordering spare parts, always give as much information as possible. Quote the vehicle model, year of manufacture, body and engine numbers as appropriate.

The *Vehicle Identification Number (VIN) plate* is riveted to the top of the body front panel, and can be viewed once the bonnet is open (see illustrations). The plate carries the VIN number, vehicle weight information and paint and trim colour codes.

The *Vehicle Identification Number (VIN)* is given on the VIN plate, and is also stamped into front right-hand side of the chassis, forward of the coil spring mounting (see illustration).

The petrol engine number is stamped onto

the left-hand bank of the cylinder block (left as seen from the driver's seat), between the centre branches of the exhaust manifold. The engine compression ratio also appears above the engine number (see illustration).

The diesel engine number is stamped into the cylinder block, on the right-hand side of the engine, above the camshaft front cover plate.

The manual transmission identification number is stamped into a flat on the bottom right-hand side of the transmission casing (see illustration).

The automatic transmission identification number is stamped on a plate riveted to the bottom left-hand side of the transmission casing (see illustration).

The transfer gearbox identification number is stamped into the lower left-hand side of the gearbox casing (see illustration).



VIN plate (arrowed)

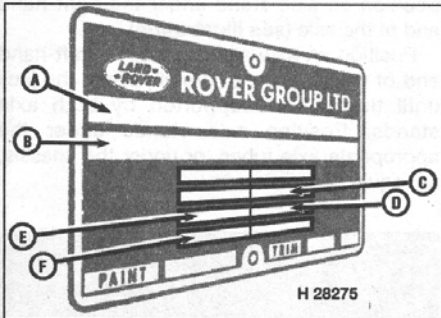

VIN plate information

- A Type approval number
- B VIN (minimum 17 digits)
- C Maximum permitted laden weight for vehicle
- D Maximum vehicle and trailer weight
- E Maximum road weight - front axle
- F Maximum road weight - rear axle

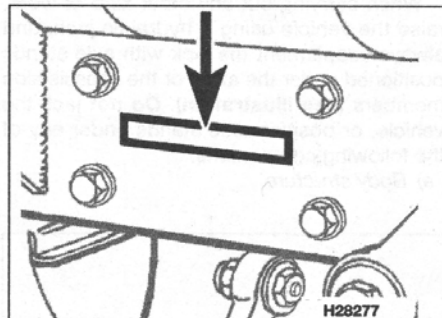

VIN stamped on right-hand side of chassis

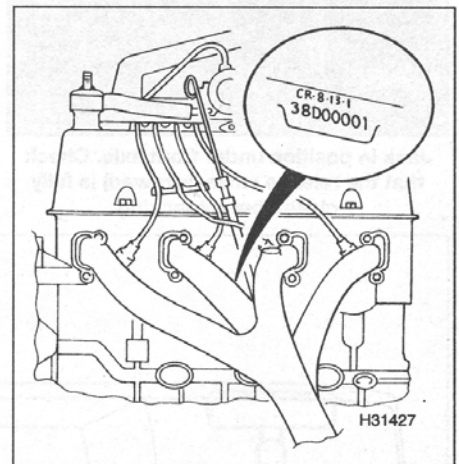

Petrol engine number location - note compression ratio (CR) details which appear above

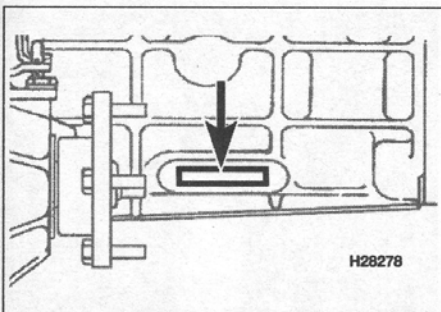

Manual gearbox identification number location

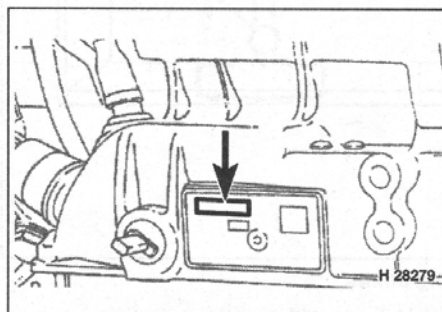

Automatic transmission identification number location

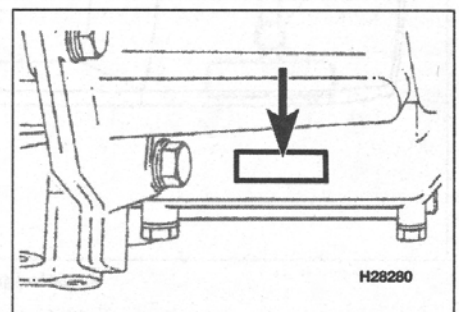

Transfer gearbox identification number location

**Warning:** The handbrake acts on the transmission, not the rear wheels, and may not hold the vehicle stationary when jacking. If one front wheel and one rear wheel are raised, no vehicle holding or braking effect is possible using the handbrake, therefore the wheels must always be chocked (using the chock supplied in the tool kit). If the vehicle is coupled to a trailer, disconnect the trailer from the vehicle before commencing jacking. This is to prevent the trailer pulling the vehicle off the jack and causing personal injury.

**Using the vehicle jack**

The jack supplied with the vehicle tool kit should only be used for changing the roadwheels, as described in *Wheel changing* at the front of this Manual.

If jacking up a front wheel, slide the jack

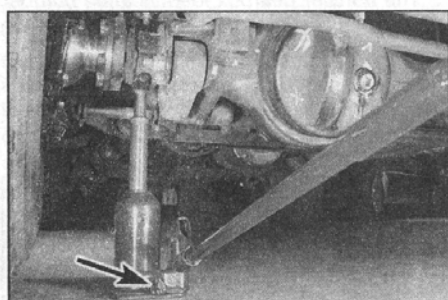

Jack in position under front axle. Check that the release valve (arrowed) is fully closed before jacking

into position from the front of the vehicle (not from the side). Position the jack head so that when raised, it will engage with the front axle casing immediately below the coil spring. The jack head must locate between the flange at the end of the axle casing and large bracket to which the front suspension components are secured (see illustration).

If raising a rear wheel, push the rear mudflap up behind the tyre to allow a clear view of the jacking point. Slide the jack into position from the rear of the vehicle. Position the jack head so that when raised, it will engage with the rear axle casing immediately below the coil spring, and as close as possible to the shock absorber mounting bracket.

**Using a hydraulic (trolley) jack and axle stands**

**Note:** To raise the vehicle, a hydraulic jack with a minimum load capacity of 1500 kg must be used. **Never** work under a vehicle supported solely by a hydraulic jack, as even a hydraulic jack could fail under load - always supplement the jack with axle stands. Do not use piles of bricks or wooden blocks for supporting - the Discovery is a heavy vehicle, and makeshift methods should not be used.

When carrying out any other kind of work, raise the vehicle using a hydraulic jack, and always supplement the jack with axle stands positioned under the axles or the chassis side members (see illustration). **Do not** jack the vehicle, or position axle stands under any of the following components:

- a) Body structure.

- b) Bumpers.
- c) Underbody pipes and hoses.
- d) Suspension components.
- e) Gearbox/transmission/transfer gearbox housings.
- f) Engine sump.
- g) Fuel tank.

Only ever jack the vehicle up on a solid, level surface. If there is even a slight slope, take great care that the vehicle cannot move as the wheels are lifted off the ground. Jacking up on an uneven or gravelled surface is not recommended, as the weight of the vehicle will not be evenly distributed, and the jack may slip as the vehicle is raised.

As far as possible, do not leave the vehicle unattended once it has been raised, particularly if children are playing nearby.

To raise the front or the rear of the vehicle, chock the appropriate roadwheels, then position the jack head under the front or rear differential casing, as appropriate (see illustration). **Note:** The differential casing is not in the centre of the axle, and the vehicle will tilt when jacked under the differential casing. This is particularly noticeable when jacking up the front of the vehicle.

Operate the jack to raise the vehicle, then position an axle stand under the right-hand end of the axle (see illustration).

Position an axle stand under the left-hand end of the axle, then carefully lower the jack until the axle is supported by both axle stands. Position axle stands under the appropriate axle tubes, or under the chassis, as required.

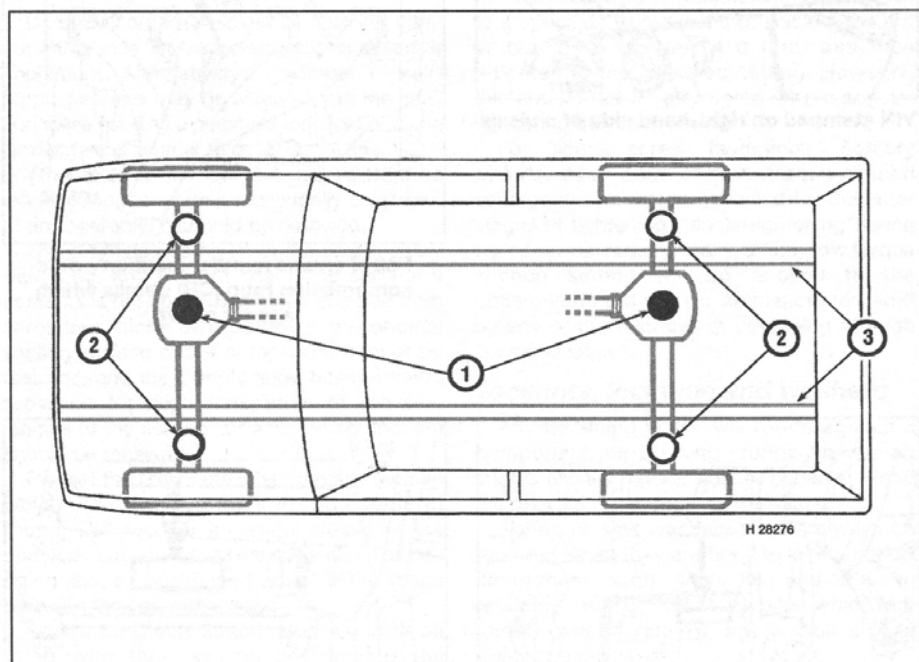

Vehicle jacking points

- 1 Jacking points for use with hydraulic jack (under differential housing)
- 2 Support points for use with axle stands (under axle tubes)
- 3 Chassis side members

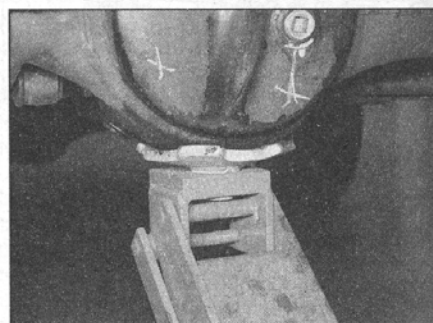

Jack positioned under front differential casing

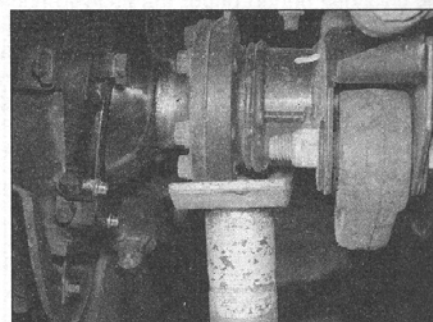

Axle stand positioned under right-hand end of front axle

# Radio/cassette unit anti-theft system - precaution REF•7

The radio/cassette unit fitted as standard equipment by Land Rover may be equipped with a built-in security code, to deter thieves. If the power source to the unit is cut, the anti-theft system will activate. Even if the power source is immediately reconnected, the radio/cassette unit will not function until the correct security code has been entered.

Therefore, if you do not know the correct security code for the radio/cassette unit, **do not** disconnect the battery negative terminal of the battery, or remove the radio/cassette unit from the vehicle.

To enter the correct security code, follow the instructions provided with the radio/cassette player handbook.

If an incorrect code is entered, the unit will become locked, and cannot be operated.

If this happens or if the security code is lost or forgotten, seek the advice of your Land Rover dealer. On presentation of proof of ownership, a Land Rover dealer will be able to unlock the unit and provide you with a new security code.

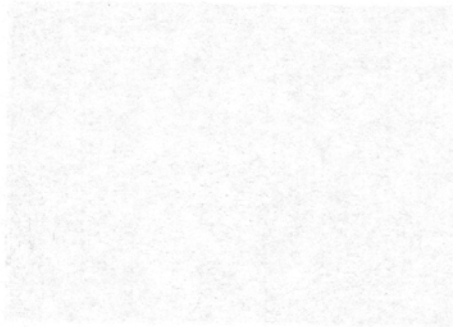

### Introduction

A selection of good tools is a fundamental requirement for anyone contemplating the maintenance and repair of a motor vehicle. For the owner who does not possess any, their purchase will prove a considerable expense, offsetting some of the savings made by doing-it-yourself. However, provided that the tools purchased meet the relevant national safety standards and are of good quality, they will last for many years and prove an extremely worthwhile investment.

To help the average owner to decide which tools are needed to carry out the various tasks detailed in this manual, we have compiled three lists of tools under the following headings: *Maintenance and minor repair*, *Repair and overhaul*, and *Special*. Newcomers to practical mechanics should start off with the *Maintenance and minor repair* tool kit, and confine themselves to the simpler jobs around the vehicle. Then, as confidence and experience grow, more difficult tasks can be undertaken, with extra tools being purchased as, and when, they are needed. In this way, a *Maintenance and minor repair* tool kit can be built up into a *Repair and overhaul* tool kit over a considerable period of time, without any major cash outlays. The experienced do-it-yourselfer will have a tool kit good enough for most repair and overhaul procedures, and will add tools from the *Special* category when it is felt that the expense is justified by the amount of use to which these tools will be put.

### Maintenance and minor repair tool kit

The tools given in this list should be considered as a minimum requirement if routine maintenance, servicing and minor repair operations are to be undertaken. We recommend the purchase of combination spanners (ring one end, open-ended the other); although more expensive than open-ended ones, they do give the advantages of both types of spanner.

- Combination spanners:**
  - Metric - 8 to 19 mm inclusive
  - Adjustable spanner - 35 mm jaw (approx.)
  - Spark plug spanner (with rubber insert) - petrol models
  - Spark plug gap adjustment tool - petrol models
  - Set of feeler gauges
  - Brake bleed nipple spanner
- Screwdrivers:**
  - Flat blade - 100 mm long x 6 mm dia
  - Cross blade - 100 mm long x 6 mm dia
  - Torx - various sizes (not all vehicles)
- Combination pliers
- Hacksaw (junior)
- Tyre pump
- Tyre pressure gauge
- Oil can
- Oil filter removal tool
- Fine emery cloth
- Wire brush (small)
- Funnel (medium size)
- Sump drain plug key (not all vehicles)

### Repair and overhaul tool kit

These tools are virtually essential for anyone undertaking any major repairs to a motor vehicle, and are additional to those given in the *Maintenance and minor repair* list. Included in this list is a comprehensive set of sockets. Although these are expensive, they will be found invaluable as they are so versatile - particularly if various drives are included in the set. We recommend the half-inch square-drive type, as this can be used with most proprietary torque wrenches.

The tools in this list will sometimes need to be supplemented by tools from the *Special* list:

- Sockets (or box spanners) to cover range in previous list (including Torx sockets)
- Reversible ratchet drive (for use with sockets)
- Extension piece, 250 mm (for use with sockets)
- Universal joint (for use with sockets)
- Flexible handle or sliding T "breaker bar" (for use with sockets)
- Torque wrench (for use with sockets)
- Self-locking grips
- Ball pein hammer
- Soft-faced mallet (plastic or rubber)
- Screwdrivers:**
  - Flat blade - long & sturdy, short (chubby), and narrow (electrician's) types
  - Cross blade - long & sturdy, and short (chubby) types
- Pliers:**
  - Long-nosed
  - Side cutters (electrician's)
  - Circlip (internal and external)
- Cold chisel - 25 mm
- Scriber
- Scraper
- Centre-punch
- Pin punch
- Hacksaw
- Brake hose clamp
- Brake/clutch bleeding kit
- Selection of twist drills
- Steel rule/straight-edge
- Allen keys (inc. splined/Torx type)
- Selection of files
- Wire brush
- Axle stands
- Jack (strong trolley or hydraulic type)
- Light with extension lead
- Universal electrical multi-meter

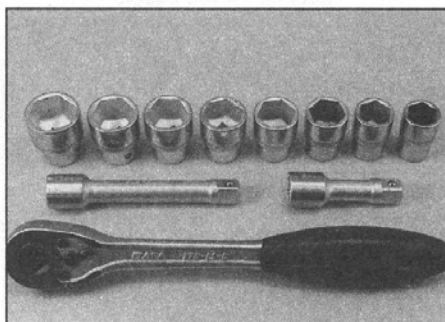

Sockets and reversible ratchet drive

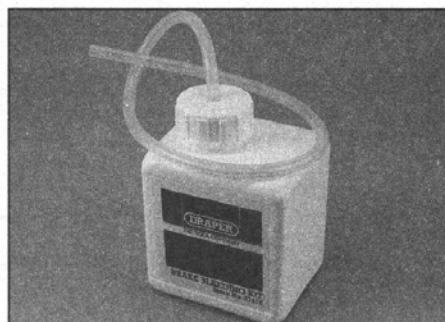

Brake bleeding kit



Torx key, socket and bit

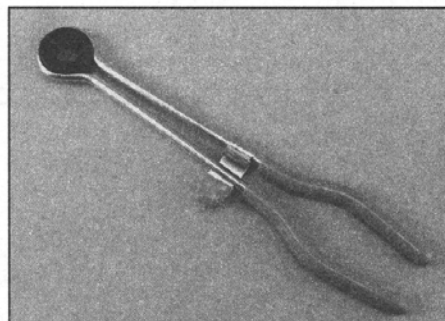

Hose clamp

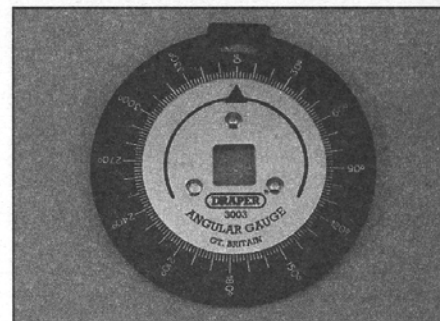

Angular-tightening gauge



## Special tools

The tools in this list are those which are not used regularly, are expensive to buy, or which need to be used in accordance with their manufacturers' instructions. Unless relatively difficult mechanical jobs are undertaken frequently, it will not be economic to buy many of these tools. Where this is the case, you could consider clubbing together with friends (or joining a motorists' club) to make a joint purchase, or borrowing the tools against a deposit from a local garage or tool hire specialist. It is worth noting that many of the larger DIY superstores now carry a large range of special tools for hire at modest rates.

The following list contains only those tools and instruments freely available to the public, and not those special tools produced by the vehicle manufacturer specifically for its dealer network. You will find occasional references to these manufacturers' special tools in the text of this manual. Generally, an alternative method of doing the job without the vehicle manufacturers' special tool is given. However, sometimes there is no alternative to using them. Where this is the case and the relevant tool cannot be bought or borrowed, you will have to entrust the work to a dealer.

- Angular-tightening gauge
- Valve spring compressor
- Valve grinding tool
- Piston ring compressor
- Piston ring removal/installation tool
- Cylinder bore hone
- Balljoint separator
- Coil spring compressors (where applicable)
- Two/three-legged hub and bearing puller
- Impact screwdriver
- Micrometer and/or vernier calipers
- Dial gauge
- Stroboscopic timing light
- Dwell angle meter/tachometer
- Fault code reader
- Cylinder compression gauge
- Hand-operated vacuum pump and gauge
- Clutch plate alignment set
- Brake shoe steady spring cup removal tool
- Bush and bearing removal/installation set
- Stud extractors
- Tap and die set
- Lifting tackle
- Trolley jack

## Buying tools

Reputable motor accessory shops and superstores often offer excellent quality tools at discount prices, so it pays to shop around.

Remember, you don't have to buy the most expensive items on the shelf, but it is always advisable to steer clear of the very cheap tools. Beware of 'bargains' offered on market stalls or at car boot sales. There are plenty of good tools around at reasonable prices, but always aim to purchase items which meet the relevant national safety standards. If in doubt, ask the proprietor or manager of the shop for advice before making a purchase.

## Care and maintenance of tools

Having purchased a reasonable tool kit, it is necessary to keep the tools in a clean and serviceable condition. After use, always wipe off any dirt, grease and metal particles using a clean, dry cloth, before putting the tools away. Never leave them lying around after they have been used. A simple tool rack on the garage or workshop wall for items such as screwdrivers and pliers is a good idea. Store all normal spanners and sockets in a metal box. Any measuring instruments, gauges, meters, etc, must be carefully stored where they cannot be damaged or become rusty.

Take a little care when tools are used. Hammer heads inevitably become marked, and screwdrivers lose the keen edge on their blades from time to time. A little timely attention with emery cloth or a file will soon restore items like this to a good finish.

## Working facilities

Not to be forgotten when discussing tools is the workshop itself. If anything more than routine maintenance is to be carried out, a suitable working area becomes essential.

It is appreciated that many an owner-mechanic is forced by circumstances to remove an engine or similar item without the benefit of a garage or workshop. Having done this, any repairs should always be done under the cover of a roof.

Wherever possible, any dismantling should be done on a clean, flat workbench or table at a suitable working height.

Any workbench needs a vice; one with a jaw opening of 100 mm is suitable for most jobs. As mentioned previously, some clean dry storage space is also required for tools, as well as for any lubricants, cleaning fluids, touch-up paints etc, which become necessary.

Another item which may be required, and which has a much more general usage, is an electric drill with a chuck capacity of at least 8 mm. This, together with a good range of twist drills, is virtually essential for fitting accessories.

Last, but not least, always keep a supply of old newspapers and clean, lint-free rags available, and try to keep any working area as clean as possible.



Micrometers

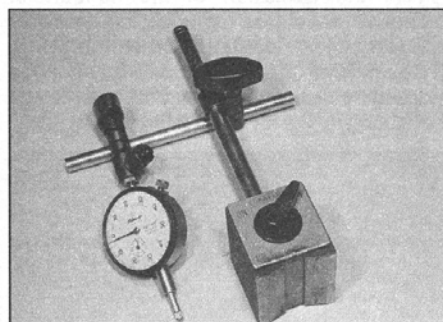

Dial test indicator ("dial gauge")



Strap wrench

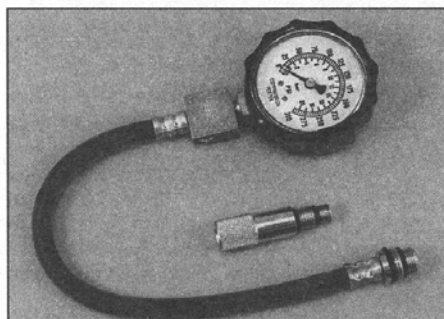

Compression tester



Fault code reader

This is a guide to getting your vehicle through the MOT test. Obviously it will not be possible to examine the vehicle to the same standard as the professional MOT tester. However, working through the following checks will enable you to identify any problem areas before submitting the vehicle for the test.

Where a testable component is in borderline condition, the tester has discretion in deciding whether to pass or fail it. The basis of such discretion is whether the tester would be happy for a close relative or friend to use the vehicle with the component in that condition. If the vehicle presented is clean and evidently well cared for, the tester may be more inclined to pass a borderline component than if the vehicle is scruffy and apparently neglected.

It has only been possible to summarise the test requirements here, based on the regulations in force at the time of printing. Test standards are becoming increasingly stringent, although there are some exemptions for older vehicles.

An assistant will be needed to help carry out some of these checks.



The checks have been sub-divided into four categories, as follows:

- |  |  |   |   |
|--|--|---|---|
| <p><b>1</b> Checks carried out <b>FROM THE DRIVER'S SEAT</b></p> | <p><b>2</b> Checks carried out <b>WITH THE VEHICLE ON THE GROUND</b></p> | <p><b>3</b> Checks carried out <b>WITH THE VEHICLE RAISED AND THE WHEELS FREE TO TURN</b></p> | <p><b>4</b> Checks carried out on <b>YOUR VEHICLE'S EXHAUST EMISSION SYSTEM</b></p> |
|--|--|---|---|

**1** Checks carried out **FROM THE DRIVER'S SEAT**

**Handbrake**

- Test the operation of the handbrake. Excessive travel (too many clicks) indicates incorrect brake or cable adjustment.
- Check that the handbrake cannot be released by tapping the lever sideways. Check the security of the lever mountings.

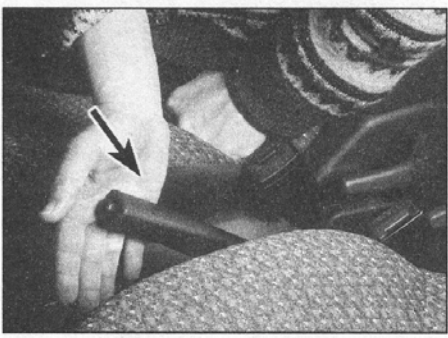

**Footbrake**

- Depress the brake pedal and check that it does not creep down to the floor, indicating a master cylinder fault. Release the pedal, wait a few seconds, then depress it again. If the pedal travels nearly to the floor before firm resistance is felt, brake adjustment or repair is necessary. If the pedal feels spongy, there is air in the hydraulic system which must be removed by bleeding.

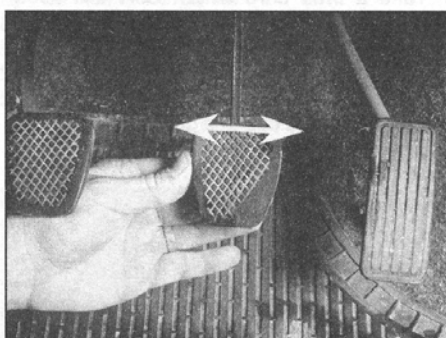

- Check that the brake pedal is secure and in good condition. Check also for signs of fluid leaks on the pedal, floor or carpets, which would indicate failed seals in the brake master cylinder.
- Check the servo unit (when applicable) by operating the brake pedal several times, then keeping the pedal depressed and starting the engine. As the engine starts, the pedal will move down slightly. If not, the vacuum hose or the servo itself may be faulty.

**Steering wheel and column**

- Examine the steering wheel for fractures or looseness of the hub, spokes or rim.
- Move the steering wheel from side to side and then up and down. Check that the steering wheel is not loose on the column, indicating wear or a loose retaining nut. Continue moving the steering wheel as before, but also turn it slightly from left to right.
- Check that the steering wheel is not loose on the column, and that there is no abnormal

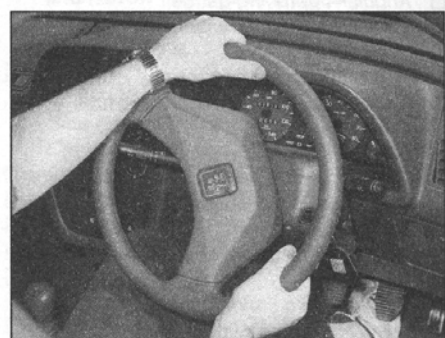

movement of the steering wheel, indicating wear in the column support bearings or couplings.

**Windscreen, mirrors and sunvisor**

- The windscreen must be free of cracks or other significant damage within the driver's field of view. (Small stone chips are acceptable.) Rear view mirrors must be secure, intact, and capable of being adjusted.

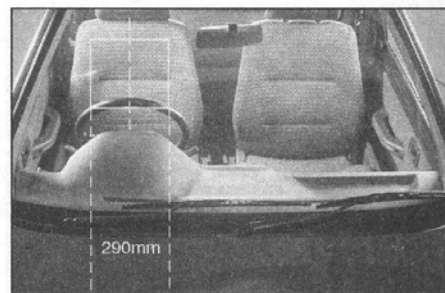

- The driver's sunvisor must be capable of being stored in the "up" position.

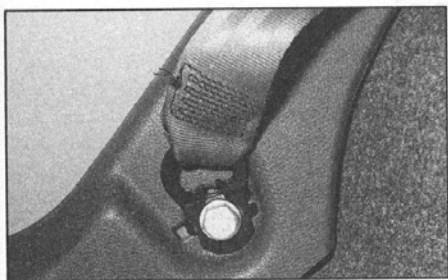

**Seat belts and seats**

**Note:** The following checks are applicable to all seat belts, front and rear.

- Examine the webbing of all the belts (including rear belts if fitted) for cuts, serious fraying or deterioration. Fasten and unfasten each belt to check the buckles. If applicable, check the retracting mechanism. Check the security of all seat belt mountings accessible from inside the vehicle.
- Seat belts with pre-tensioners, once activated, have a "flag" or similar showing on the seat belt stalk. This, in itself, is not a reason for test failure.
- The front seats themselves must be securely attached and the backrests must lock in the upright position.

**Electrical equipment**

- Switch on the ignition and check the operation of the horn.
- Check the windscreen washers and wipers, examining the wiper blades; renew damaged or perished blades. Also check the operation of the stop-lights.

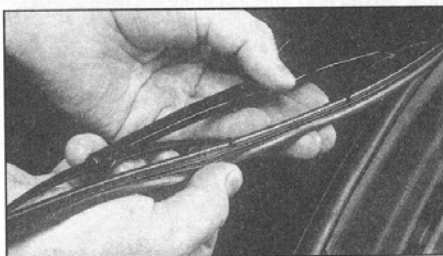

- Check the operation of the sidelights and number plate lights. The lenses and reflectors must be secure, clean and undamaged.
- Check the operation and alignment of the headlights. The headlight reflectors must not be tarnished and the lenses must be undamaged.
- Switch on the ignition and check the operation of the direction indicators (including the instrument panel tell-tale) and the hazard warning lights. Operation of the sidelights and stop-lights must not affect the indicators - if it does, the cause is usually a bad earth at the rear light cluster.
- Check the operation of the rear foglight(s), including the warning light on the instrument panel or in the switch.
- The ABS warning light must illuminate in accordance with the manufacturers' design. For most vehicles, the ABS warning light should illuminate when the ignition is switched on, and (if the system is operating properly) extinguish after a few seconds. Refer to the owner's handbook.

- Inspect both front brake flexible hoses for cracks or deterioration of the rubber. Turn the steering from lock to lock, and ensure that the hoses do not contact the wheel, tyre, or any part of the steering or suspension mechanism. With the brake pedal firmly depressed, check the hoses for bulges or leaks under pressure.

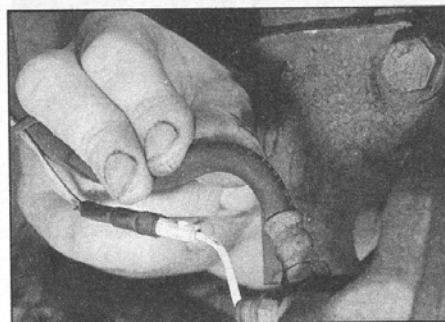

**Doors**

- Both front doors must be able to be opened and closed from outside and inside, and must latch securely when closed.

**2** Checks carried out WITH THE VEHICLE ON THE GROUND

**Vehicle identification**

- Number plates must be in good condition, secure and legible, with letters and numbers correctly spaced - spacing at (A) should be at least twice that at (B).

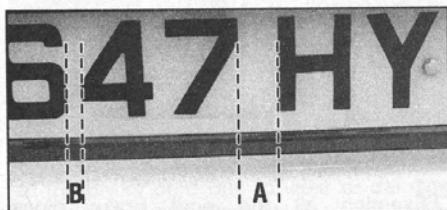

- The VIN plate and/or homologation plate must be legible.



**Footbrake**

- Examine the master cylinder, brake pipes and servo unit for leaks, loose mountings, corrosion or other damage.

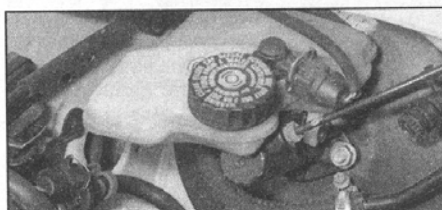

- The fluid reservoir must be secure and the fluid level must be between the upper (A) and lower (B) markings.

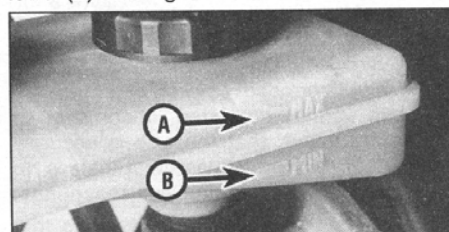

**Steering and suspension**

- Have your assistant turn the steering wheel from side to side slightly, up to the point where the steering gear just begins to transmit this movement to the roadwheels. Check for excessive free play between the steering wheel and the steering gear, indicating wear or insecurity of the steering column joints, the column-to-steering gear coupling, or the steering gear itself.
- Have your assistant turn the steering wheel more vigorously in each direction, so that the roadwheels just begin to turn. As this is done, examine all the steering joints, linkages, fittings and attachments. Renew any component that shows signs of wear or damage. On vehicles with power steering, check the security and condition of the steering pump, drivebelt and hoses.
- Check that the vehicle is standing level, and at approximately the correct ride height.

**Shock absorbers**

- Depress each corner of the vehicle in turn, then release it. The vehicle should rise and then settle in its normal position. If the vehicle continues to rise and fall, the shock absorber is defective. A shock absorber which has seized will also cause the vehicle to fail.



**Exhaust system**

□ Start the engine. With your assistant holding a rag over the tailpipe, check the entire system for leaks. Repair or renew leaking sections.

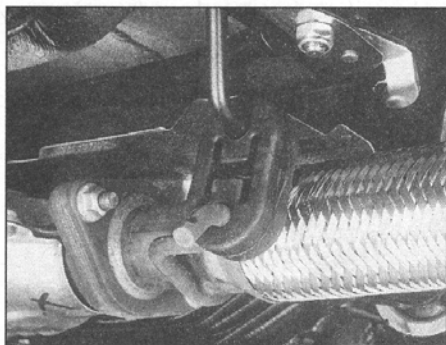

**3** Checks carried out  
**WITH THE VEHICLE RAISED  
AND THE WHEELS FREE TO  
TURN**

*Jack up the front and rear of the vehicle, and securely support it on axle stands. Position the stands clear of the suspension assemblies. Ensure that the wheels are clear of the ground and that the steering can be turned from lock to lock.*

**Steering mechanism**

□ Have your assistant turn the steering from lock to lock. Check that the steering turns smoothly, and that no part of the steering mechanism, including a wheel or tyre, fouls any brake hose or pipe or any part of the body structure.

□ Examine the steering rack rubber gaiters for damage or insecurity of the retaining clips. If power steering is fitted, check for signs of damage or leakage of the fluid hoses, pipes or connections. Also check for excessive stiffness or binding of the steering, a missing split pin or locking device, or severe corrosion of the body structure within 30 cm of any steering component attachment point.

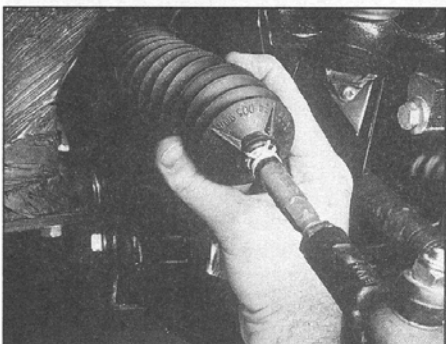
**Front and rear suspension and wheel bearings**

□ Starting at the front right-hand side, grasp the roadwheel at the 3 o'clock and 9 o'clock positions and rock gently but firmly. Check for free play or insecurity at the wheel bearings, suspension balljoints, or suspension mountings, pivots and attachments.

□ Now grasp the wheel at the 12 o'clock and 6 o'clock positions and repeat the previous inspection. Spin the wheel, and check for roughness or tightness of the front wheel bearing.

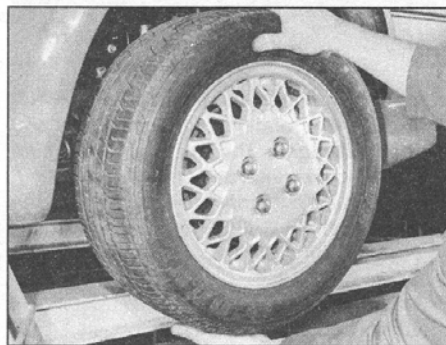

□ If excess free play is suspected at a component pivot point, this can be confirmed by using a large screwdriver or similar tool and levering between the mounting and the component attachment. This will confirm whether the wear is in the pivot bush, its retaining bolt, or in the mounting itself (the bolt holes can often become elongated).

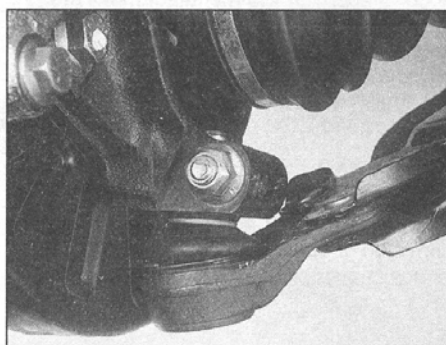

□ Carry out all the above checks at the other front wheel, and then at both rear wheels.

**Springs and shock absorbers**

□ Examine the suspension struts (when applicable) for serious fluid leakage, corrosion, or damage to the casing. Also check the security of the mounting points.

□ If coil springs are fitted, check that the spring ends locate in their seats, and that the spring is not corroded, cracked or broken.

□ If leaf springs are fitted, check that all leaves are intact, that the axle is securely attached to each spring, and that there is no deterioration of the spring eye mountings, bushes, and shackles.

□ The same general checks apply to vehicles fitted with other suspension types, such as torsion bars, hydraulic displacer units, etc. Ensure that all mountings and attachments are secure, that there are no signs of excessive wear, corrosion or damage, and (on hydraulic types) that there are no fluid leaks or damaged pipes.

□ Inspect the shock absorbers for signs of serious fluid leakage. Check for wear of the mounting bushes or attachments, or damage to the body of the unit.

**Driveshafts (fwd vehicles only)**

□ Rotate each front wheel in turn and inspect the constant velocity joint gaiters for splits or damage. Also check that each driveshaft is straight and undamaged.

**Braking system**

□ If possible without dismantling, check brake pad wear and disc condition. Ensure that the friction lining material has not worn excessively, (A) and that the discs are not fractured, pitted, scored or badly worn (B).

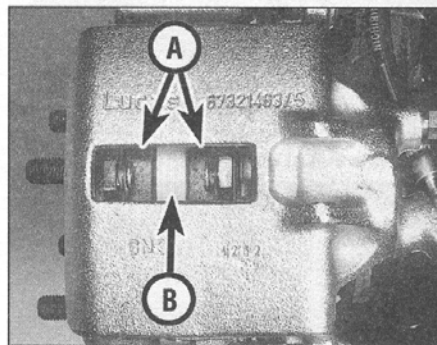

□ Examine all the rigid brake pipes underneath the vehicle, and the flexible hose(s) at the rear. Look for corrosion, chafing or insecurity of the pipes, and for signs of bulging under pressure, chafing, splits or deterioration of the flexible hoses.

□ Look for signs of fluid leaks at the brake calipers or on the brake backplates. Repair or renew leaking components.

□ Slowly spin each wheel, while your assistant depresses and releases the footbrake. Ensure that each brake is operating and does not bind when the pedal is released.

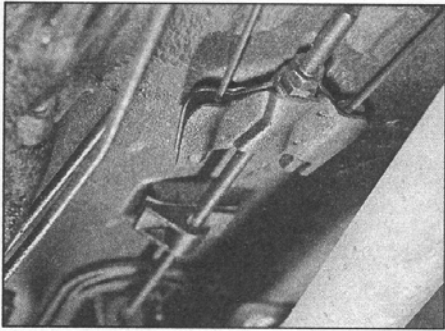

- Examine the handbrake mechanism, checking for frayed or broken cables, excessive corrosion, or wear or insecurity of the linkage. Check that the mechanism works on each relevant wheel, and releases fully, without binding.
- It is not possible to test brake efficiency without special equipment, but a road test can be carried out later to check that the vehicle pulls up in a straight line.

### Fuel and exhaust systems

- Inspect the fuel tank (including the filler cap), fuel pipes, hoses and unions. All components must be secure and free from leaks.
- Examine the exhaust system over its entire length, checking for any damaged, broken or missing mountings, security of the retaining clamps and rust or corrosion.

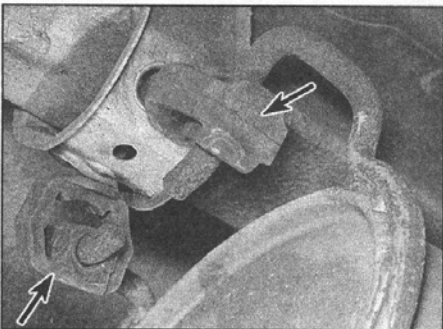

### Wheels and tyres

- Examine the sidewalls and tread area of each tyre in turn. Check for cuts, tears, lumps, bulges, separation of the tread, and exposure of the ply or cord due to wear or damage. Check that the tyre bead is correctly seated on the wheel rim, that the valve is sound and properly seated, and that the wheel is not distorted or damaged.
- Check that the tyres are of the correct size for the vehicle, that they are of the same size and type on each axle, and that the pressures are correct.
- Check the tyre tread depth. The legal minimum at the time of writing is 1.6 mm over at least three-quarters of the tread width. Abnormal tread wear may indicate incorrect front wheel alignment.

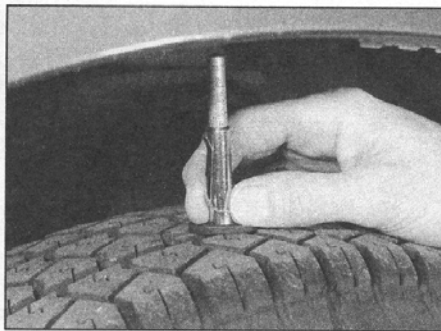

### Body corrosion

- Check the condition of the entire vehicle structure for signs of corrosion in load-bearing areas. (These include chassis box sections, side sills, cross-members, pillars, and all suspension, steering, braking system and seat belt mountings and anchorages.) Any corrosion which has seriously reduced the thickness of a load-bearing area is likely to cause the vehicle to fail. In this case professional repairs are likely to be needed.
- Damage or corrosion which causes sharp or otherwise dangerous edges to be exposed will also cause the vehicle to fail.

## 4 Checks carried out on YOUR VEHICLE'S EXHAUST EMISSION SYSTEM

### Petrol models

- Have the engine at normal operating temperature, and make sure that it is in good tune (ignition system in good order, air filter element clean, etc).
- Before any measurements are carried out, raise the engine speed to around 2500 rpm, and hold it at this speed for 20 seconds. Allow the engine speed to return to idle, and watch for smoke emissions from the exhaust tailpipe. If the idle speed is obviously much too high, or if dense blue or clearly-visible black smoke comes from the tailpipe for more than 5 seconds, the vehicle will fail. As a rule of thumb, blue smoke signifies oil being burnt (engine wear) while black smoke signifies unburnt fuel (dirty air cleaner element, or other carburettor or fuel system fault).
- An exhaust gas analyser capable of measuring carbon monoxide (CO) and hydrocarbons (HC) is now needed. If such an instrument cannot be hired or borrowed, a local garage may agree to perform the check for a small fee.

### CO emissions (mixture)

- At the time of writing, for vehicles first used between 1<sup>st</sup> August 1975 and 31<sup>st</sup> July 1986 (P to C registration), the CO level must not exceed 4.5% by volume. For vehicles first used between 1<sup>st</sup> August 1986 and 31<sup>st</sup> July 1992 (D to J registration), the CO level must not exceed 3.5% by volume. Vehicles first

used after 1<sup>st</sup> August 1992 (K registration) must conform to the manufacturer's specification. The MOT tester has access to a DOT database or emissions handbook, which lists the CO and HC limits for each make and model of vehicle. The CO level is measured with the engine at idle speed, and at "fast idle". The following limits are given as a general guide:

*At idle speed -*

CO level no more than 0.5%

*At "fast idle" (2500 to 3000 rpm) -*

CO level no more than 0.3%

(Minimum oil temperature 60°C)

- If the CO level cannot be reduced far enough to pass the test (and the fuel and ignition systems are otherwise in good condition) then the carburettor is badly worn, or there is some problem in the fuel injection system or catalytic converter (as applicable).

### HC emissions

- With the CO within limits, HC emissions for vehicles first used between 1<sup>st</sup> August 1975 and 31<sup>st</sup> July 1992 (P to J registration) must not exceed 1200 ppm. Vehicles first used after 1<sup>st</sup> August 1992 (K registration) must conform to the manufacturer's specification. The MOT tester has access to a DOT database or emissions handbook, which lists the CO and HC limits for each make and model of vehicle. The HC level is measured with the engine at "fast idle". The following is given as a general guide:

*At "fast idle" (2500 to 3000 rpm) -*

HC level no more than 200 ppm

(Minimum oil temperature 60°C)

- Excessive HC emissions are caused by incomplete combustion, the causes of which can include oil being burnt, mechanical wear and ignition/fuel system malfunction.

### Diesel models

- The only emission test applicable to Diesel engines is the measuring of exhaust smoke density. The test involves accelerating the engine several times to its maximum unloaded speed.

**Note:** It is of the utmost importance that the engine timing belt is in good condition before the test is carried out.

- The limits for Diesel engine exhaust smoke, introduced in September 1995 are:

*Vehicles first used before 1<sup>st</sup> August 1979:*

Exempt from metered smoke testing, but must not emit "dense blue or clearly visible black smoke for a period of more than 5 seconds at idle" or "dense blue or clearly visible black smoke during acceleration which would obscure the view of other road users".

*Non-turbocharged vehicles first used after*

*1<sup>st</sup> August 1979: 2.5m<sup>-1</sup>*

*Turbocharged vehicles first used after*

*1<sup>st</sup> August 1979: 3.0m<sup>-1</sup>*

- Excessive smoke can be caused by a dirty air cleaner element. Otherwise, professional advice may be needed to find the cause.

**Engine**

- Engine fails to rotate when attempting to start
- Starter motor turns engine slowly
- Starter motor spins without turning engine
- Starter motor noisy or excessively-rough in engagement
- Engine rotates but will not start
- Engine fires but will not run
- Engine difficult to start when cold
- Engine difficult to start when hot
- Engine idles erratically
- Engine misfires at idle speed
- Engine misfires throughout the driving speed range
- Engine stalls
- Engine lacks power
- Oil pressure warning light illuminated with engine running
- Engine runs-on after switching off
- Engine noises

**Cooling system**

- Overheating
- Overcooling
- External coolant leakage
- Internal coolant leakage
- Corrosion

**Fuel and exhaust systems**

- Excessive fuel consumption
- Fuel leakage and/or fuel odour
- Excessive noise or fumes from exhaust system

**Clutch**

- Pedal travels to floor - no pressure or very little resistance
- Clutch fails to disengage (unable to select gears)
- Clutch slips (engine speed increases, with no increase in vehicle speed)
- Judder as clutch is engaged
- Noise when depressing or releasing clutch pedal

**Manual gearbox**

- Noisy in neutral with engine running
- Noisy in one particular gear
- Difficulty engaging gears
- Jumps out of gear
- Vibration
- Lubricant leaks

**Automatic transmission**

- Fluid leakage
- Transmission fluid brown, or has burned smell
- General gear selection problems
- Transmission will not downshift (kickdown) with accelerator fully depressed
- Engine will not start in any gear, or starts in gears other than Park or Neutral
- Transmission slips, shifts roughly, is noisy, or has no drive in forward or reverse gears

**Transfer gearbox**

- Noisy in neutral with engine running
- Noisy in Low or High positions
- Difficulty engaging ranges
- Jumps out of gear
- Vibration
- Lubricant leaks

**Propeller shafts**

- Knock or clunk when taking up drive
- Oil leak where propeller shaft enters transfer gearbox
- Oil leak where propeller shaft enters axle
- Metallic grating sound consistent with vehicle speed
- Scraping noise
- Vibration

**Front and rear axles**

- Vibration
- Noise on drive and overrun
- Noise consistent with road speed
- Knock or clunk when taking up drive
- Oil leakage

**Braking system**

- Vehicle pulls to one side under braking
- Noise (grinding or high-pitched squeal) when brakes applied
- Excessive brake pedal travel
- Brake pedal feels spongy when depressed
- Excessive brake pedal effort required to stop vehicle
- Judder felt through brake pedal or steering wheel when braking
- Brakes binding
- Rear wheels locking under normal braking

**Suspension and steering**

- Vehicle pulls to one side
- Wheel wobble and vibration
- Excessive pitching and/or rolling around corners, or during braking
- Wandering or general instability
- Excessively-stiff steering
- Excessive play in steering
- Lack of power assistance
- Tyre wear excessive

**Electrical system**

- Battery will not hold a charge for more than a few days
- Ignition/no-charge warning light remains illuminated with engine running
- Ignition/no-charge warning light fails to come on
- Lights inoperative
- Instrument readings inaccurate or erratic
- Horn inoperative, or unsatisfactory in operation
- Windscreen/tailgate wipers inoperative, or unsatisfactory in operation
- Windscreen/tailgate washers inoperative, or unsatisfactory in operation
- Electric windows inoperative, or unsatisfactory in operation
- Central locking system inoperative, or unsatisfactory in operation

## Introduction

The vehicle owner who does his or her own maintenance according to the recommended service schedules should not have to use this section of the manual very often. Modern component reliability is such that, provided those items subject to wear or deterioration are inspected or renewed at the specified

intervals, sudden failure is comparatively rare. Faults do not usually just happen as a result of sudden failure, but develop over a period of time. Major mechanical failures in particular are usually preceded by characteristic symptoms over hundreds or even thousands of miles. Those components which do

occasionally fail without warning are often small and easily carried in the vehicle.

With any fault-finding, the first step is to decide where to begin investigations. Sometimes this is obvious, but on other occasions, a little detective work will be necessary. The owner who makes half a dozen

haphazard adjustments or replacements may be successful in curing a fault (or its symptoms), but will be none the wiser if the fault recurs, and ultimately may have spent more time and money than was necessary. A calm and logical approach will be found to be more satisfactory in the long run. Always take into account any warning signs or abnormalities that may have been noticed in the period preceding the fault - power loss, high or low gauge readings, unusual smells, etc - and remember that failure of components such as fuses or relays may only be pointers to some underlying fault.

The pages which follow provide an easy reference guide to the more common problems which may occur during the

operation of the vehicle. These problems and their possible causes are grouped under headings denoting various components or systems, such as Engine, Cooling system, etc. The Chapter and/or Section which deals with the problem is also shown in brackets. Whatever the fault, certain basic principles apply. These are as follows:

*Verify the fault.* This is simply a matter of being sure that you know what the symptoms are before starting work. This is particularly important if you are investigating a fault for someone else, who may not have described it very accurately.

*Don't overlook the obvious.* For example, if the vehicle won't start, is there fuel in the tank? (Don't take anyone else's word on this particular

point, and don't trust the fuel gauge either!) If an electrical fault is indicated, look for loose or broken wires before digging out the test gear.

*Cure the disease, not the symptom.* Substituting a flat battery with a fully-charged one will get you off the hard shoulder, but if the underlying cause is not attended to, the new battery will go the same way.

*Don't take anything for granted.* Particularly, don't forget that a 'new' component may itself be defective (especially if it's been rattling around in the boot for months), and don't leave components out of a fault diagnosis sequence just because they are new or recently fitted. When you do finally diagnose a difficult fault, you'll probably realise that all the evidence was there from the start.

## Engine

### Engine fails to rotate when attempting to start

- Battery terminal connections loose or corroded (*Weekly checks*).
- Battery discharged or faulty (Chapter 5A).
- Broken, loose or disconnected wiring in the starting circuit (Chapter 5A).
- Automatic transmission not in P or N (Chapter 7B).
- Defective starter solenoid or switch (Chapter 5A).
- Defective starter motor (Chapter 5A).
- Starter pinion or flywheel ring gear teeth loose or broken (Chapters 2A, 2B, 2C and 5A).
- Engine earth strap broken or disconnected (Chapter 5A).

### Engine rotates, but will not start

- Fuel tank empty.
- Battery discharged (engine rotates slowly) (Chapter 5A).
- Battery terminal connections loose or corroded (*Weekly checks*).
- Immobiliser fault (Chapter 13).
- Ignition components damp or damaged - petrol models (Chapters 1 and 5B).
- Ignition timing incorrect (Chapter 5B).
- Broken, loose or disconnected wiring in the ignition circuit - petrol models (Chapter 5B).
- Worn, faulty or incorrectly-gapped spark plugs - petrol models (Chapter 1A).
- Preheating system faulty - diesel models (Chapter 5C).
- Fuel injection system fault - petrol models (Chapter 4A or 4B).
- Fuel cut-off (stop) solenoid faulty - diesel models (Chapter 4C).
- Air in fuel system - diesel models (Chapter 4C).
- Major mechanical failure (eg camshaft drive) (Chapter 2A, 2B or 2C).

### Engine difficult to start when cold

- Battery discharged (Chapter 5A).
- Ignition timing incorrect (Chapter 5B).
- Battery terminal connections loose or corroded (*Weekly checks*).
- Worn, faulty or incorrectly-gapped spark plugs - petrol models (Chapter 1A).
- Preheating system faulty - diesel models (Chapter 5C).
- Wax formed in fuel - diesel models (in very cold weather).
- Fuel injection system fault - petrol models (Chapter 4A or 4B).
- Other ignition system fault - petrol models (Chapter 5B).
- Low cylinder compressions (Chapter 2A or 2B).

### Engine difficult to start when hot

- Air filter element dirty or clogged (Chapter 1).
- Carburettor or fuel injection system fault - petrol models (Chapter 4A or 4B).
- Low cylinder compressions (Chapter 2A or 2B).
- Ignition timing incorrect (Chapter 5B).

### Starter motor noisy or excessively-rough in engagement

- Starter pinion or flywheel ring gear teeth loose or broken (Chapters 2A, 2B and 5A).
- Starter motor mounting bolts loose or missing (Chapter 5A).
- Starter motor internal components worn or damaged (Chapter 5A).

### Engine starts, but stops immediately

- Loose or faulty electrical connections in the ignition circuit - petrol models (Chapter 5B).
- Vacuum leak at the carburettor/plenum chamber, inlet manifold or associated hoses - petrol models (Chapter 4A or 4B).
- Carburettor/fuel injection system fault - petrol models (Chapter 4A or 4B).
- Fuel pump fault - petrol models (Chapter 4A or 4B).
- Fuel lines restricted (Chapter 4).
- Wax formed in fuel - diesel models (in very cold weather).

### Engine idles erratically

- Air filter element clogged (Chapter 1).
- Vacuum leak at the carburettor/plenum chamber, inlet manifold or associated hoses - petrol models (Chapter 4A or 4B).
- Worn, faulty or incorrectly-gapped spark plugs - petrol models (Chapter 1A).
- Uneven or low cylinder compressions (Chapter 2A or 2B).
- Camshaft lobes worn (Chapter 2A or 2B).
- Valve clearances incorrect - diesel models (Chapter 1B).
- Timing belt incorrectly tensioned - diesel models (Chapter 2B).
- Carburettor/fuel injection system fault - petrol models (Chapter 4A or 4B).
- Faulty injector(s) - diesel models (Chapter 4C).
- Wax formed in fuel - diesel models (in very cold weather).

### Engine misfires at idle speed

- Worn, faulty or incorrectly-gapped spark plugs - petrol models (Chapter 1A).
- Faulty spark plug HT leads - petrol models (Chapter 5B).
- Vacuum leak at the carburettor/plenum chamber, inlet manifold or associated hoses - petrol models (Chapter 4A or 4B).
- Carburettor/fuel injection system fault - petrol models (Chapter 4A or 4B).
- Faulty injector(s) - diesel models (Chapter 4C).
- Valve clearances incorrect - diesel models (Chapter 1B).
- Distributor cap cracked or tracking internally - petrol models (Chapter 5B).
- Uneven or low cylinder compressions (Chapter 2A or 2B).
- Disconnected, leaking, or perished crankcase ventilation hoses (Chapter 4D).

**Engine (continued)****Engine misfires throughout the driving speed range**

- Fuel filter choked (Chapter 1).
- Fuel pump faulty, or delivery pressure low - petrol models (Chapter 4A or 4B).
- Fuel tank vent blocked, or fuel pipes restricted (Chapter 4A, 4B or 4C).
- Vacuum leak at the carburettor/plenum chamber, inlet manifold or associated hoses - petrol models (Chapter 4A or 4B).
- Worn, faulty or incorrectly-gapped spark plugs - petrol models (Chapter 1A).
- Faulty spark plug HT leads - petrol models (Chapter 5B).
- Faulty injector(s) - diesel models (Chapter 4C).
- Valve clearances incorrect - diesel models (Chapter 1B).
- Distributor cap cracked or tracking internally - petrol models (Chapter 5B).
- Faulty ignition coil - petrol models (Chapter 5B).
- Uneven or low cylinder compressions (Chapter 2A or 2B).
- Carburettor/fuel injection system fault - petrol models (Chapter 4A or 4B).

**Engine hesitates on acceleration**

- Worn, faulty or incorrectly-gapped spark plugs - petrol models (Chapter 1A).
- Vacuum leak at the carburettor/plenum chamber, inlet manifold or associated hoses - petrol models (Chapter 4A or 4B).
- Carburettor/fuel injection system fault - petrol models (Chapter 4A or 4B).
- Faulty injector(s) - diesel models (Chapter 4C).
- Valve clearances incorrect - diesel models (Chapter 1B).

**Engine stalls**

- Vacuum leak at the carburettor/plenum chamber, inlet manifold or associated hoses - petrol models (Chapter 4A or 4B).
- Fuel filter choked (Chapter 1).
- Fuel pump faulty, or delivery pressure low - petrol models (Chapter 4A or 4B).
- Fuel tank vent blocked, or fuel pipes restricted (Chapter 4A, 4B or 4C).
- Carburettor/fuel injection system fault - petrol models (Chapter 4A or 4B).
- Faulty injector(s) - diesel models (Chapter 4C).
- Wax formed in fuel - diesel models (in very cold weather).

**Engine lacks power**

- Timing chain or belt incorrectly fitted or tensioned (Chapter 2A or 2B).
- Fuel filter choked (Chapter 1).
- Ignition timing incorrect - petrol models (Chapter 5B).
- Fuel pump faulty, or delivery pressure low - petrol models (Chapter 4A or 4B).
- Fuel lines leaking or restricted (Chapter 4A, 4B, or 4C).
- Uneven or low cylinder compressions (Chapter 2A or 2B).
- Worn, faulty or incorrectly-gapped spark plugs - petrol models (Chapter 1A).
- Vacuum leak at the carburettor/plenum chamber, inlet manifold or associated hoses - petrol models (Chapter 4A or 4B).
- Carburettor/fuel injection system fault - petrol models (Chapter 4A or 4B).
- Faulty injector(s) - diesel models (Chapter 4C).
- Injection pump timing incorrect - diesel models (Chapter 4C).
- Wax formed in fuel - diesel models (in very cold weather).
- Brakes binding (Chapters 1 and 10).
- Clutch slipping (Chapter 6).

**Engine backfires**

- Timing chain or belt incorrectly fitted or tensioned (Chapter 2A or 2B).
- Vacuum leak at the carburettor/plenum chamber, inlet manifold or associated hoses - petrol models (Chapter 4A or 4B).
- Carburettor/fuel injection system fault - petrol models (Chapter 4A or 4B).
- Ignition timing incorrect - petrol models (Chapter 5B).

**Oil pressure warning light illuminated with engine running**

- Low oil level, or incorrect oil grade (*Weekly checks*).
- Worn engine bearings and/or oil pump (Chapter 2C).
- High engine operating temperature (Chapter 3).
- Oil pressure relief valve defective (Chapter 2A or 2B).
- Oil pick-up strainer clogged (Chapter 2A or 2B).

**Engine runs-on after switching off**

- Excessive carbon build-up in engine (Chapter 2C).
- High engine operating temperature (Chapter 3).
- Carburettor/fuel injection system fault - petrol models (Chapter 4A or 4B).
- Faulty fuel cut-off (stop) solenoid - diesel models (Chapter 4C).

**Engine noises**

**Note:** *To inexperienced ears, a diesel engine can sound alarming even when there is nothing wrong with it, so it may be prudent to have an unusual noise expertly diagnosed before making renewals or repairs.*

**Pre-ignition (pinking) or knocking during acceleration or under load**

- Ignition timing incorrect/ignition system fault - petrol models (Chapter 5B).
- Incorrect grade of spark plug - petrol models (Chapter 1A).
- Incorrect grade of fuel.
- Vacuum leak at the carburettor/plenum chamber, inlet manifold or associated hoses - petrol models (Chapter 4A or 4B).
- Excessive carbon build-up in engine (Chapter 2C).
- Carburettor/fuel injection system fault - petrol models (Chapter 4A or 4B).
- Overheating (Refer to *Cooling system* of Fault finding).

**Whistling or wheezing noises**

- Leaking carburettor/plenum chamber or inlet manifold gasket - petrol models (Chapter 4A or 4B).
- Leaking exhaust manifold gasket or pipe-to-manifold joint (Chapter 4A, 4B or 4C).
- Leaking vacuum hose (Chapters 4, 5B and 10).
- Blowing cylinder head gasket (Chapter 2A or 2B).

**Tapping or rattling noises**

- Insufficient oil reaching hydraulic tappets (petrol models) - check oil level, or change oil (*Weekly checks* or Chapter 1A).
- Valve clearances incorrect - diesel models (Chapter 1B).
- Worn hydraulic tappet or camshaft - petrol models (Chapter 2A).
- Worn timing chain - petrol models (Chapter 2A).
- Worn camshaft - diesel models (Chapter 2B).
- Ancillary component fault (water pump, alternator, etc) (Chapters 3, 5A, etc).

**Knocking or thumping noises**

- Worn big-end bearings (regular heavy knocking, perhaps less under load) (Chapter 2C).
- Worn main bearings (rumbling and knocking, perhaps worsening under load) (Chapter 2C).
- Piston slap (indicating piston and/or bore wear - most noticeable when cold) (Chapter 2C).
- Ancillary component fault (water pump, alternator, etc) (Chapters 3, 5A, etc).



## Cooling system

### Overheating

- Insufficient coolant in system (*Weekly checks*).
- Auxiliary drivebelt broken or drivebelt tensioner faulty (Chapter 1)
- Thermostat faulty (Chapter 3).
- Radiator core blocked, or grille restricted (Chapter 3).
- Electric cooling fan or thermostitch faulty (Chapter 3 or 13).
- Pressure cap faulty (Chapter 3).
- Ignition timing incorrect/ignition system fault - petrol models (Chapter 5B).
- Inaccurate temperature gauge sender unit (Chapter 3).
- Airlock in cooling system (Chapter 1).

### Overcooling

- Thermostat faulty (Chapter 3).
- Inaccurate temperature gauge sender unit (Chapter 3).

### External coolant leakage

- Deteriorated or damaged hoses or hose clips (Chapter 1).
- Radiator core or heater matrix leaking (Chapter 3).
- Pressure cap faulty (Chapter 3).
- Water pump seal leaking (Chapter 3).
- Boiling due to overheating (Chapter 3).
- Core plug leaking (Chapter 2C).

### Internal coolant leakage

- Leaking cylinder head gasket (Chapter 2A or 2B).
- Cracked cylinder head or cylinder bore (Chapter 2A or 2B).

### Corrosion

- Infrequent draining and flushing (Chapter 1).
- Incorrect coolant mixture or inappropriate coolant type (Chapter 1).

## Fuel and exhaust systems

### Excessive fuel consumption

- Air filter element dirty or clogged (Chapter 1).
- Carburettor float level too high - petrol models (Chapter 4A).
- Fuel injectors partially blocked - petrol models (Chapter 4B).
- Other carburettor or fuel injection system fault - petrol models (Chapter 4A or 4B).
- Faulty injector(s) - diesel models (Chapter 4C).
- Fuel tank/lines damaged or leaking, or fuel return line restricted (Chapter 4).
- Ignition timing incorrect/ignition system fault - petrol models (Chapter 5B).

- Tyres under-inflated (*Weekly checks*).
- Brakes binding (Chapter 10).

### Fuel leakage and/or fuel odour

- Damaged or corroded fuel tank, pipes or connections (Chapter 4).

### Excessive noise or fumes from exhaust system

- Leaking exhaust system or manifold joints (Chapters 1 and 4).
- Leaking, corroded or damaged silencers or pipe (Chapters 1 and 4).
- Broken mountings causing body or suspension contact (Chapter 1).

## Clutch

### Judder as clutch is engaged

- Clutch disc linings contaminated with oil or grease (Chapter 6).
- Clutch disc linings excessively worn (Chapter 6).
- Clutch cable sticking or frayed (Chapter 6).
- Faulty or distorted pressure plate or diaphragm spring (Chapter 6).
- Worn or loose engine/transmission mountings (Chapter 2).
- Clutch disc hub or gearbox input shaft splines worn (Chapter 6).

### Clutch fails to disengage (unable to select gears)

- Leak in clutch hydraulic system (Chapter 6).
- Faulty hydraulic master or slave cylinder (Chapter 6).
- Clutch disc sticking on gearbox input shaft splines (Chapter 6).
- Clutch disc sticking to flywheel or pressure plate (Chapter 6).
- Faulty pressure plate assembly (Chapter 6).
- Clutch release mechanism worn or incorrectly assembled (Chapter 6).

### Clutch slips (engine speed increases, with no increase in vehicle speed)

- Clutch disc linings excessively worn (Chapter 6).
- Clutch disc linings contaminated with oil or grease (Chapter 6).
- Faulty pressure plate or weak diaphragm spring (Chapter 6).

### Pedal travels to floor - no pressure or very little resistance

- Leak in clutch hydraulic system (Chapter 6).
- Faulty hydraulic master or slave cylinder (Chapter 6).
- Broken clutch release bearing or fork (Chapter 6).
- Broken diaphragm spring in clutch pressure plate (Chapter 6).

### Noise when depressing or releasing clutch pedal

- Worn clutch release bearing (Chapter 6).
- Worn or dry clutch pedal bushes (Chapter 6).
- Faulty pressure plate assembly (Chapter 6).
- Pressure plate diaphragm spring broken (Chapter 6).
- Broken clutch disc cushioning springs (Chapter 6).

## Manual transmission

### Difficulty engaging gears

- Clutch fault (Chapter 6).
- Worn or damaged gear linkage (Chapter 7A).
- Worn synchroniser units (Chapter 7A).\*

### Jumps out of gear

- Worn or damaged gear linkage (Chapter 7A).
- Incorrectly-adjusted gear linkage (Chapter 7A).
- Worn synchroniser units (Chapter 7A).\*
- Worn selector forks (Chapter 7A).\*

### Vibration

- Lack of oil (Chapter 1).
- Worn bearings (Chapter 7A).\*

### Noisy in one particular gear

- Worn, damaged or chipped gear teeth (Chapter 7A).\*

### Noisy in neutral with engine running

- Input shaft and/or mainshaft bearings worn (noise apparent with clutch pedal released, but not when depressed) (Chapter 7A).\*
- Clutch release bearing worn (noise apparent with clutch pedal depressed, possibly less when released) (Chapter 6).

### Lubricant leaks

- Leaking oil seal (Chapter 7A).
- Leaking housing joint (Chapter 7A).\*

*\*Although the corrective action necessary to remedy the symptoms described is beyond the scope of the home mechanic, the above information should be helpful in isolating the cause of the condition, so that the owner can communicate clearly with a professional mechanic.*

## Automatic transmission

**Note:** Due to the complexity of the automatic transmission, it is difficult for the home mechanic to properly diagnose and service this unit. For problems other than the following, the vehicle should be taken to a dealer service department or automatic transmission specialist.

### Fluid leakage

- Automatic transmission fluid is usually deep red in colour. Fluid leaks should not be confused with engine oil, which can easily be blown onto the transmission by air flow.
- To determine the source of a leak, first remove all built-up dirt and grime from the transmission housing and surrounding areas, using a degreasing agent or by steam-cleaning. Drive the vehicle at low speed, so that air flow will not blow the leak far from its source. Raise and support the vehicle, and determine where the leak is coming from. The following are common areas of leakage.
  - a) Fluid pan (transmission sump).
  - b) Dipstick tube (Chapter 1).
  - c) Transmission-to-fluid cooler fluid pipes/unions (Chapter 7B).

### Transmission fluid brown, or has burned smell

- Transmission fluid level low, or fluid in need of renewal (Chapter 1).

### Transmission will not downshift (kickdown) with accelerator pedal fully depressed

- Low transmission fluid level (Chapter 1).
- Incorrect selector cable adjustment (Chapter 7B).

### General gear selection problems

- The most likely cause of gear selection problems is a faulty or poorly-adjusted gear selector mechanism. The following are common problems associated with a faulty selector mechanism:
  - a) Engine starting in gears other than Park or Neutral.
  - b) Indicator on gear selector lever pointing to a gear other than the one actually being used.
  - c) Vehicle moves when in Park or Neutral.
  - d) Poor gear shift quality, or erratic gear changes.
- Refer any problems to a Land Rover dealer, or an automatic transmission specialist.

### Engine will not start in any gear, or starts in gears other than Park or Neutral

- Incorrect starter inhibitor switch adjustment (Chapter 7B).
- Incorrect selector cable adjustment (Chapter 7B).

### Transmission slips, shifts roughly, is noisy, or has no drive in forward or reverse gears

- There are many probable causes for the above problems, but the home mechanic should be concerned with only one possibility - fluid level. Before taking the vehicle to a dealer or transmission specialist, check the fluid level and condition of the fluid as described in Chapter 1. Correct the fluid level as necessary, or change the fluid and filter if needed. If the problem persists, professional help will be necessary.

## Transfer gearbox

### Noisy in neutral with engine running

- Worn mainshaft or output shaft bearings (Chapter 7C).\*

### Noisy in Low or High positions

- Worn, damaged or chipped gear teeth (Chapter 7C).\*

### Jumps out of gear

- Worn or damaged gear linkage (Chapter 7C).\*
- Worn selector fork (Chapter 7C).\*

### Vibration

- Lack of oil (Chapter 1).
- Worn bearings (Chapter 7C).\*

### Difficulty engaging ranges

- Clutch fault (Chapter 6).
- Main transmission fault (Chapter 7A or 7B).
- Worn selector fork (Chapter 7C).\*

### Lubricant leaks

- Leaking oil seal (Chapter 7C).\*
- Leaking housing joint (Chapter 7C).\*

\*Although the corrective action necessary to remedy the symptoms described is beyond the scope of the home mechanic, the above information should be helpful in isolating the cause of the condition, so that the owner can communicate clearly with a professional mechanic.

## Propeller shafts

### Knock or clunk when taking up drive

- Worn universal joint bearings (Chapter 8).
- Worn axle drive pinion splines (Chapter 9).
- Loose drive flange bolts (Chapter 8).
- Excessive backlash in axle gears (Chapter 9).

### Metallic grating sound, consistent with vehicle speed

- Severe wear in universal joint bearings (Chapter 8).

### Vibration

- Wear in sliding sleeve splines (Chapter 8).
- Worn universal joint bearings (Chapter 8).
- Propeller shaft out of balance (Chapter 8).

## Front and rear axles

### Vibration

- Propeller shaft out of balance (Chapter 8).
- Worn hub bearings (Chapter 9).
- Wheels out of balance.
- Propeller shaft or halfshaft joints worn (Chapters 8 and 9).
- Suspension or steering fault (Chapter 11).

### Noise on drive and overrun

- Worn crownwheel and pinion gears (Chapter 9).
- Worn differential bearings (Chapter 9).
- Lack of lubrication in axle or swivel pin housings (Chapters 9 and 11).
- Main transmission or transfer gearbox fault (Chapter 7).

### Noise consistent with road speed

- Worn hub bearings (Chapter 9).
- Worn differential bearings (Chapter 9).

- Lack of lubrication in axle or swivel pin housings (Chapters 9 and 11).
- Main transmission or transfer gearbox fault (Chapter 7).

### Knock or clunk when taking up drive

- Excessive crownwheel and pinion backlash (Chapter 9).
- Worn propeller shaft or halfshaft joints (Chapters 8 and 9).
- Worn halfshaft splines (Chapter 9).
- Halfshaft bolts or roadwheel nuts loose (Chapter 9).
- Broken, damaged, or worn suspension components or axle mountings (Chapters 11 and 9).
- Main transmission or transfer gearbox fault (Chapter 7).

### Oil leakage

- Faulty differential pinion or halfshaft oil seals (Chapter 9).
- Blocked axle breather valve (Chapter 9).
- Damaged swivel pin housing or oil seal (Chapter 11).

## Braking system

**Note:** Before assuming that a brake problem exists, make sure that the tyres are in good condition and correctly inflated, the front wheel alignment is correct, and the vehicle is not loaded with weight in an unequal manner. Apart from checking the condition of all pipe and hose connections, any faults occurring on the anti-lock braking system should be referred to a Land Rover dealer for diagnosis.

### Vehicle pulls to one side under braking

- Worn, defective, damaged or contaminated front or rear brake pads on one side (Chapter 10).
- Seized or partially-seized front or rear brake caliper piston (Chapter 10).
- A mixture of brake pad lining materials fitted between sides (Chapter 10).
- Brake caliper mounting bolts loose (Chapter 10).
- Worn or damaged steering or suspension components (Chapter 11).

### Noise (grinding or high-pitched squeal) when brakes applied

- Brake pad friction lining material worn down to metal backing (Chapter 10).
- Brake pads incorrectly fitted, or pad backing plates dry (Chapter 10).
- Excessive corrosion of brake disc - may be apparent after the vehicle has been standing for some time (Chapter 10).

### Excessive brake pedal travel

- Faulty master cylinder (Chapter 10).
- Air in hydraulic system (Chapter 10).
- Faulty vacuum servo unit (Chapter 10).
- Faulty brake vacuum pump - diesel models (Chapter 10).

### Brake pedal feels spongy when depressed

- Air in hydraulic system (Chapter 10).
- Deteriorated flexible rubber brake hoses (Chapter 10).
- Master cylinder mountings loose (Chapter 10).
- Faulty master cylinder (Chapter 10).

### Excessive brake pedal effort required to stop vehicle

- Faulty vacuum servo unit (Chapter 10).
- Disconnected, damaged or insecure brake servo vacuum hose (Chapters 1 and 10).
- Faulty brake vacuum pump (Chapter 10).
- Primary or secondary hydraulic circuit failure (Chapter 10).
- Seized brake caliper piston(s) (Chapter 10).
- Brake pads incorrectly fitted (Chapter 10).
- Incorrect grade of brake pads fitted (Chapter 10).
- Brake pads contaminated (Chapter 10).

### Judder felt through brake pedal or steering wheel when braking

**Note:** Under heavy braking, models equipped with ABS may exhibit a 'pulsing' sensation felt through the brake pedal. This is a normal feature of ABS operation, and does not necessarily indicate a fault.

- Excessive run-out or distortion of brake disc(s) (Chapter 10).
- Brake pad linings worn (Chapter 10).
- Brake caliper mounting bolts loose (Chapter 10).
- Wear in suspension or steering components or mountings (Chapter 11).

### Brakes binding

- Seized brake caliper piston(s) (Chapter 10).
- Faulty master cylinder (Chapter 10).

### Rear wheels locking under normal braking

- Faulty brake pressure regulator (Chapter 10).

## Suspension and steering

**Note:** Before diagnosing suspension or steering faults, be sure that the trouble is not due to incorrect tyre pressures, mixtures of tyre types or binding brakes.

### Vehicle pulls to one side

- Defective tyre (*Weekly checks*).
- Excessive wear in suspension or steering components (Chapter 11).
- Incorrect front wheel alignment (Chapter 11).
- Accident damage to steering or suspension components (Chapter 11).

### Wheel wobble and vibration

- Front roadwheels out of balance - vibration felt mainly through the steering wheel (Chapter 11).
- Rear roadwheels out of balance - vibration felt throughout the vehicle (Chapter 11).
- Roadwheels damaged or distorted (*Weekly checks*).
- Faulty or damaged tyre (*Weekly checks*).
- Worn steering or suspension joints, bushes or components (Chapter 11).
- Wheel nuts loose (*Wheel changing*).

### Excessive pitching and/or rolling around corners or during braking

- Defective shock absorbers (Chapter 11).
- Broken or weak coil spring and/or suspension component (Chapter 11).
- Worn or damaged anti-roll bar or mountings (Chapter 11).

### Wandering or general instability

- Incorrect front wheel alignment (Chapter 11).
- Worn steering or suspension joints, bushes or components (Chapter 11).
- Roadwheels out of balance (*Weekly checks*).
- Faulty or damaged tyre (*Weekly checks*).
- Wheel nuts loose (*Wheel changing*).
- Defective shock absorbers (Chapter 11).

### Excessively-stiff steering

- Lack of steering gear lubricant (Chapter 11).
- Seized track-rod end balljoint (Chapter 11).
- Broken or incorrectly-adjusted power steering pump drivebelt (Chapter 1).

- Incorrect front wheel alignment (Chapter 11).
- Steering box or column damaged (Chapter 11).

### Excessive play in steering

- Worn steering column universal joint(s) or intermediate coupling (Chapter 11).
- Worn steering track-rod end balljoints (Chapter 11).
- Worn steering box (Chapter 11).
- Worn steering or suspension joints, bushes or components (Chapter 11).

### Lack of power assistance

- Broken or incorrectly-adjusted power steering pump drivebelt (Chapter 1).
- Incorrect power steering fluid level (*Weekly checks*).
- Restriction in power steering fluid hoses (Chapter 1).
- Faulty power steering pump (Chapter 11).
- Faulty steering box (Chapter 11).

### Tyre wear excessive

#### Tyres worn on inside or outside edges

- Tyres under-inflated (wear on both edges) (*Weekly checks*).
- Incorrect camber or castor angles (wear on one edge only) (Chapter 11).
- Worn steering or suspension joints, bushes or components (Chapter 11).
- Excessively hard cornering.
- Accident damage.

#### Tyre treads exhibit feathered edges

- Incorrect toe setting (Chapter 11).

#### Tyres worn in centre of tread

- Tyres over-inflated (*Weekly checks*).

#### Tyres worn on inside and outside edges

- Tyres under-inflated (*Weekly checks*).

#### Tyres worn unevenly

- Tyres out of balance (*Weekly checks*).
- Faulty tyre (*Weekly checks*).
- Excessive wheel or tyre run-out (*Weekly checks*).
- Worn shock absorbers (Chapter 11).

## Electrical system

**Note:** For problems associated with the starting system, refer to the faults listed under *Engine* earlier in this Section.

### Battery will not hold a charge for more than a few days

- Battery defective internally (Chapter 5A).
- Battery electrolyte level low - where applicable (Chapter 1).
- Battery terminal connections loose or corroded (*Weekly checks*).
- Alternator drivebelt worn or incorrectly adjusted (Chapter 1).
- Alternator not charging at correct output (Chapter 5A).
- Alternator or voltage regulator faulty (Chapter 5A).
- Short-circuit causing continual battery drain (Chapter 5A or 13).

### Ignition/no-charge warning light remains illuminated with engine running

- Alternator drivebelt broken, worn, or incorrectly adjusted (Chapter 1).
- Alternator brushes worn, sticking, or dirty (Chapter 5A).
- Alternator brush springs weak or broken (Chapter 5A).
- Internal fault in alternator or voltage regulator (Chapter 5A).
- Broken, disconnected, or loose wiring in charging circuit (Chapter 5A).

### Ignition/no-charge warning light fails to come on

- Warning light bulb blown (Chapter 13).
- Broken, disconnected, or loose wiring in warning light circuit (Chapter 13).
- Alternator faulty (Chapter 5A).

### Lights inoperative

- Bulb blown (*Weekly checks* or Chapter 13).
- Corrosion of bulb or bulbholder contacts (Chapter 13).
- Blown fuse (*Weekly checks* or Chapter 13).
- Faulty relay (Chapter 13).
- Broken, loose, or disconnected wiring (Chapter 13).
- Faulty switch (Chapter 13).

### Instrument readings inaccurate or erratic

#### Instrument readings increase with engine speed

- Faulty voltage regulator (Chapter 13).

#### Fuel or temperature gauge give no reading

- Faulty gauge sender unit (Chapters 3 or 4).
- Wiring open-circuit (Chapter 13).
- Faulty gauge (Chapter 13).

#### Fuel or temperature gauges give continuous maximum reading

- Faulty gauge sender unit (Chapters 3 or 4).
- Wiring short-circuit (Chapter 13).
- Faulty gauge (Chapter 13).

### Horn inoperative, or unsatisfactory in operation

#### Horn operates all the time

- Horn push either earthed or stuck down (Chapter 13).
- Horn cable to horn push earthed (Chapter 13).

#### Horn fails to operate

- Blown fuse (*Weekly checks* or Chapter 13).
- Cable or cable connections loose, broken or disconnected (Chapter 13).
- Faulty horn (Chapter 13).

### Horn emits intermittent or unsatisfactory sound

- Cable connections loose (Chapter 13).
- Horn mountings loose (Chapter 13).
- Faulty horn (Chapter 13).

### Windscreen/tailgate wipers inoperative, or unsatisfactory in operation

#### Wipers fail to operate, or operate very slowly

- Wiper blades stuck to screen, or linkage seized or binding (Chapters 1 and 13).
- Blown fuse (*Weekly checks* or Chapter 13).
- Cable or cable connections loose, broken or disconnected (Chapter 13).
- Faulty relay (Chapter 13).
- Faulty wiper motor (Chapter 13).

#### Wiper blades sweep over too large or too small an area of the glass

- Wiper arms incorrectly positioned on spindles (Chapter 13).
- Excessive wear of wiper linkage (Chapter 13).
- Wiper motor or linkage mountings loose or insecure (Chapter 13).

#### Wiper blades fail to clean the glass effectively

- Wiper blade rubbers worn or perished (*Weekly checks*).
- Wiper arm tension springs broken, or arm pivots seized (Chapter 13).
- Insufficient windscreen washer additive to adequately remove road film (*Weekly checks*).

### Windscreen/tailgate washers inoperative, or unsatisfactory in operation

#### One or more washer jets inoperative

- Blocked washer jet (Chapter 13).
- Disconnected, kinked or restricted fluid hose (Chapter 13).
- Insufficient fluid in washer reservoir (*Weekly checks*).

#### Washer pump fails to operate

- Broken or disconnected wiring or connections (Chapter 13).
- Blown fuse (*Weekly checks* or Chapter 13).
- Faulty washer switch (Chapter 13).
- Faulty washer pump (Chapter 13).

#### Washer pump runs for some time before fluid is emitted from jets

- Faulty one-way valve in fluid supply hose (Chapter 13).

### Electric windows inoperative, or unsatisfactory in operation

#### Window glass will only move in one direction

- Faulty switch (Chapter 12).

#### Window glass slow to move

- Regulator seized or damaged, or in need of lubrication (Chapter 12).
- Door internal components or trim fouling regulator (Chapter 12).
- Faulty motor (Chapter 12).

#### Window glass fails to move

- Blown fuse (*Weekly checks* or Chapter 13).
- Faulty relay (Chapter 13).
- Broken or disconnected wiring or connections (Chapter 13).
- Faulty motor (Chapter 12).

# Electrical system (continued)

## Central locking system inoperative, or unsatisfactory in operation

### Complete system failure

- Blown fuse (*Weekly checks* or Chapter 13).
- Faulty relay (Chapter 13).
- Broken or disconnected wiring or connections (Chapter 13).

### Latch locks but will not unlock, or unlocks but will not lock

- Faulty switch (Chapter 13).
- Broken or disconnected latch operating rods or levers (Chapter 12).
- Faulty relay (Chapter 13).

## One solenoid/motor fails to operate

- Broken or disconnected wiring or connections (Chapter 13).
- Faulty solenoid/motor (Chapter 12).
- Broken, binding or disconnected latch operating rods or levers (Chapter 12).
- Fault in door latch (Chapter 12).

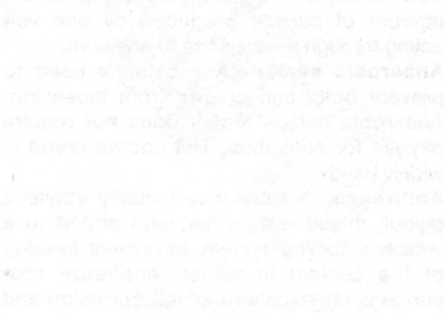
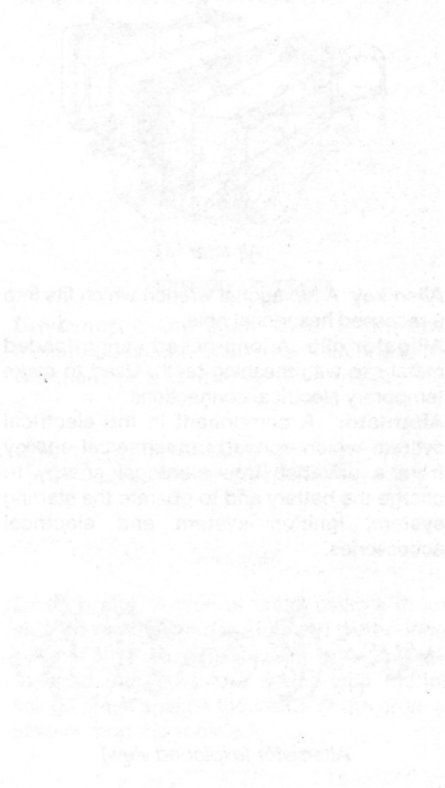
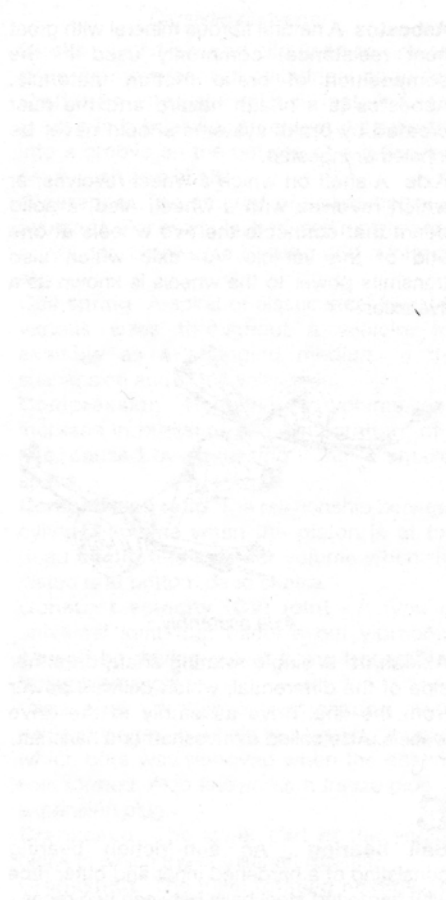

**A**

**ABS (Anti-lock brake system)** A system, usually electronically controlled, that senses incipient wheel lockup during braking and relieves hydraulic pressure at wheels that are about to skid.

**Air bag** An inflatable bag hidden in the steering wheel (driver's side) or the dash or glovebox (passenger side). In a head-on collision, the bags inflate, preventing the driver and front passenger from being thrown forward into the steering wheel or windshield.

**Air cleaner** A metal or plastic housing, containing a filter element, which removes dust and dirt from the air being drawn into the engine.

**Air filter element** The actual filter in an air cleaner system, usually manufactured from pleated paper and requiring renewal at regular intervals.

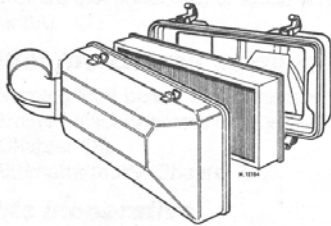

Air filter

**Allen key** A hexagonal wrench which fits into a recessed hexagonal hole.

**Alligator clip** A long-nosed spring-loaded metal clip with meshing teeth. Used to make temporary electrical connections.

**Alternator** A component in the electrical system which converts mechanical energy from a drivebelt into electrical energy to charge the battery and to operate the starting system, ignition system and electrical accessories.

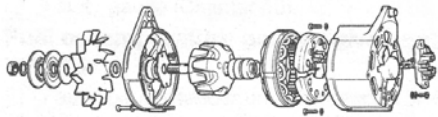

Alternator (exploded view)

**Ampere (amp)** A unit of measurement for the flow of electric current. One amp is the amount of current produced by one volt acting through a resistance of one ohm.

**Anaerobic sealer** A substance used to prevent bolts and screws from loosening. Anaerobic means that it does not require oxygen for activation. The Loctite brand is widely used.

**Antifreeze** A substance (usually ethylene glycol) mixed with water, and added to a vehicle's cooling system, to prevent freezing of the coolant in winter. Antifreeze also contains chemicals to inhibit corrosion and the formation of rust and other deposits that

would tend to clog the radiator and coolant passages and reduce cooling efficiency.

**Anti-seize compound** A coating that reduces the risk of seizing on fasteners that are subjected to high temperatures, such as exhaust manifold bolts and nuts.

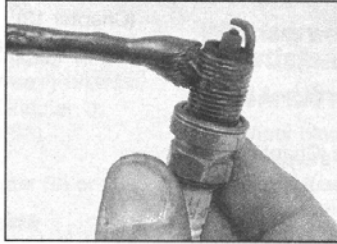

Anti-seize compound

**Asbestos** A natural fibrous mineral with great heat resistance, commonly used in the composition of brake friction materials. Asbestos is a health hazard and the dust created by brake systems should never be inhaled or ingested.

**Axle** A shaft on which a wheel revolves, or which revolves with a wheel. Also, a solid beam that connects the two wheels at one end of the vehicle. An axle which also transmits power to the wheels is known as a live axle.

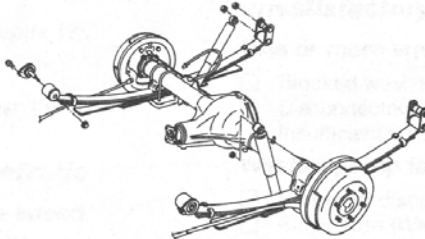

Axle assembly

**Axleshaft** A single rotating shaft, on either side of the differential, which delivers power from the final drive assembly to the drive wheels. Also called a driveshaft or a halfshaft.

**B**

**Ball bearing** An anti-friction bearing consisting of a hardened inner and outer race with hardened steel balls between two races.

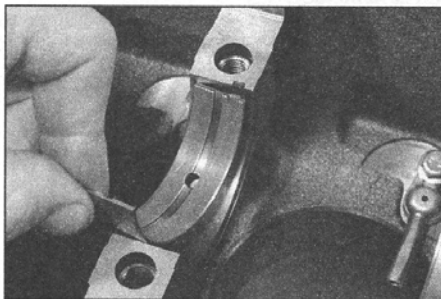

Bearing

**Bearing** The curved surface on a shaft or in a bore, or the part assembled into either, that permits relative motion between them with minimum wear and friction.

**Big-end bearing** The bearing in the end of the connecting rod that's attached to the crankshaft.

**Bleed nipple** A valve on a brake wheel cylinder, caliper or other hydraulic component that is opened to purge the hydraulic system of air. Also called a bleed screw.

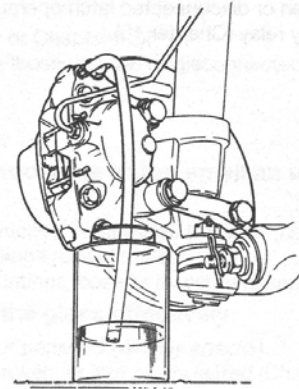

Brake bleeding

**Brake bleeding** Procedure for removing air from lines of a hydraulic brake system.

**Brake disc** The component of a disc brake that rotates with the wheels.

**Brake drum** The component of a drum brake that rotates with the wheels.

**Brake linings** The friction material which contacts the brake disc or drum to retard the vehicle's speed. The linings are bonded or riveted to the brake pads or shoes.

**Brake pads** The replaceable friction pads that pinch the brake disc when the brakes are applied. Brake pads consist of a friction material bonded or riveted to a rigid backing plate.

**Brake shoe** The crescent-shaped carrier to which the brake linings are mounted and which forces the lining against the rotating drum during braking.

**Braking systems** For more information on braking systems, consult the *Haynes Automotive Brake Manual*.

**Breaker bar** A long socket wrench handle providing greater leverage.

**Bulkhead** The insulated partition between the engine and the passenger compartment.

**C**

**Caliper** The non-rotating part of a disc-brake assembly that straddles the disc and carries the brake pads. The caliper also contains the hydraulic components that cause the pads to pinch the disc when the brakes are applied. A caliper is also a measuring tool that can be set to measure inside or outside dimensions of an object.



**Camshaft** A rotating shaft on which a series of cam lobes operate the valve mechanisms. The camshaft may be driven by gears, by sprockets and chain or by sprockets and a belt.

**Canister** A container in an evaporative emission control system; contains activated charcoal granules to trap vapours from the fuel system.

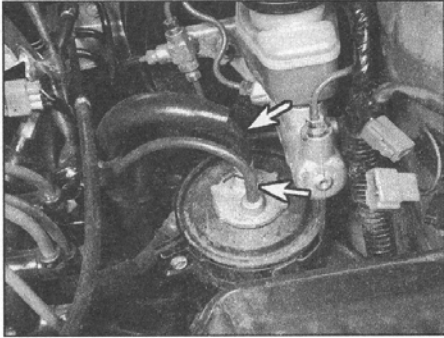

Canister

**Carburettor** A device which mixes fuel with air in the proper proportions to provide a desired power output from a spark ignition internal combustion engine.

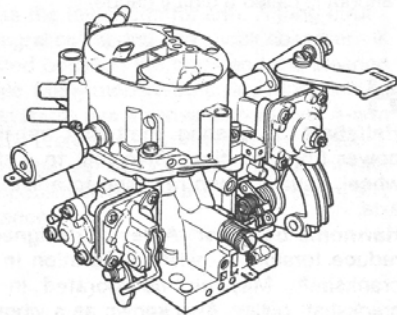

Carburettor

**Castellated** Resembling the parapets along the top of a castle wall. For example, a castellated balljoint stud nut.

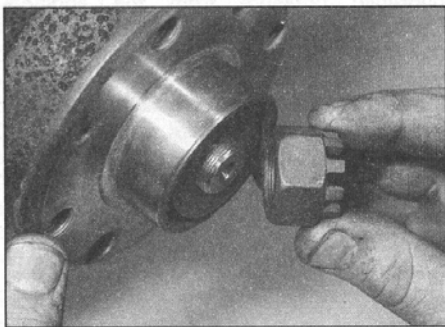

Castellated nut

**Castor** In wheel alignment, the backward or forward tilt of the steering axis. Castor is positive when the steering axis is inclined rearward at the top.

**Catalytic converter** A silencer-like device in the exhaust system which converts certain pollutants in the exhaust gases into less harmful substances.

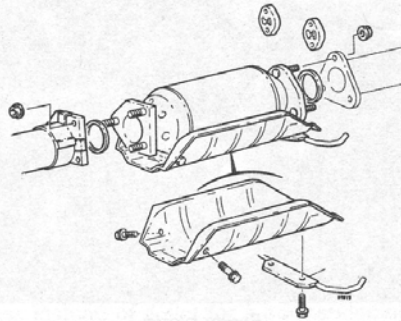

Catalytic converter

**Circlip** A ring-shaped clip used to prevent endwise movement of cylindrical parts and shafts. An internal circlip is installed in a groove in a housing; an external circlip fits into a groove on the outside of a cylindrical piece such as a shaft.

**Clearance** The amount of space between two parts. For example, between a piston and a cylinder, between a bearing and a journal, etc.

**Coil spring** A spiral of elastic steel found in various sizes throughout a vehicle, for example as a springing medium in the suspension and in the valve train.

**Compression** Reduction in volume, and increase in pressure and temperature, of a gas, caused by squeezing it into a smaller space.

**Compression ratio** The relationship between cylinder volume when the piston is at top dead centre and cylinder volume when the piston is at bottom dead centre.

**Constant velocity (CV) joint** A type of universal joint that cancels out vibrations caused by driving power being transmitted through an angle.

**Core plug** A disc or cup-shaped metal device inserted in a hole in a casting through which core was removed when the casting was formed. Also known as a freeze plug or expansion plug.

**Crankcase** The lower part of the engine block in which the crankshaft rotates.

**Crankshaft** The main rotating member, or shaft, running the length of the crankcase, with offset "throws" to which the connecting rods are attached.

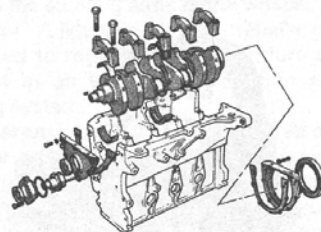

Crankshaft assembly

**Crocodile clip** See Alligator clip

## D

**Diagnostic code** Code numbers obtained by accessing the diagnostic mode of an engine management computer. This code can be used to determine the area in the system where a malfunction may be located.

**Disc brake** A brake design incorporating a rotating disc onto which brake pads are squeezed. The resulting friction converts the energy of a moving vehicle into heat.

**Double-overhead cam (DOHC)** An engine that uses two overhead camshafts, usually one for the intake valves and one for the exhaust valves.

**Drivebelt(s)** The belt(s) used to drive accessories such as the alternator, water pump, power steering pump, air conditioning compressor, etc. off the crankshaft pulley.

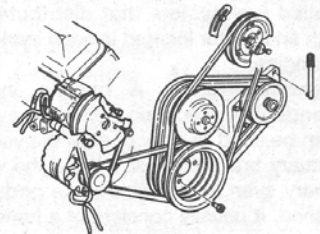

Accessory drivebelts

**Driveshaft** Any shaft used to transmit motion. Commonly used when referring to the axleshafts on a front wheel drive vehicle.

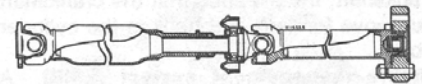

Driveshaft

**Drum brake** A type of brake using a drum-shaped metal cylinder attached to the inner surface of the wheel. When the brake pedal is pressed, curved brake shoes with friction linings press against the inside of the drum to slow or stop the vehicle.

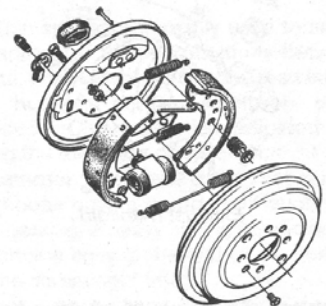

Drum brake assembly

**E**

**EGR valve** A valve used to introduce exhaust gases into the intake air stream.

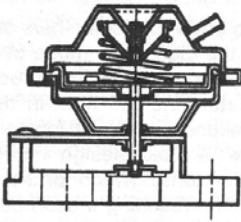

EGR valve

**Electronic control unit (ECU)** A computer which controls (for instance) ignition and fuel injection systems, or an anti-lock braking system. For more information refer to the *Haynes Automotive Electrical and Electronic Systems Manual*.

**Electronic Fuel Injection (EFI)** A computer controlled fuel system that distributes fuel through an injector located in each intake port of the engine.

**Emergency brake** A braking system, independent of the main hydraulic system, that can be used to slow or stop the vehicle if the primary brakes fail, or to hold the vehicle stationary even though the brake pedal isn't depressed. It usually consists of a hand lever that actuates either front or rear brakes mechanically through a series of cables and linkages. Also known as a handbrake or parking brake.

**Endfloat** The amount of lengthwise movement between two parts. As applied to a crankshaft, the distance that the crankshaft can move forward and back in the cylinder block.

**Engine management system (EMS)** A computer controlled system which manages the fuel injection and the ignition systems in an integrated fashion.

**Exhaust manifold** A part with several passages through which exhaust gases leave the engine combustion chambers and enter the exhaust pipe.

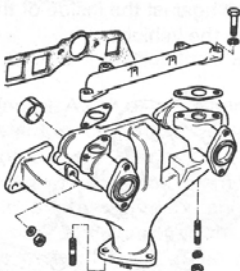

Exhaust manifold

**F**

**Fan clutch** A viscous (fluid) drive coupling device which permits variable engine fan speeds in relation to engine speeds.

**Feeler blade** A thin strip or blade of hardened steel, ground to an exact thickness, used to check or measure clearances between parts.

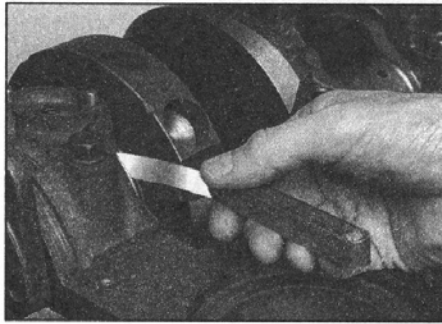

Feeler blade

**Firing order** The order in which the engine cylinders fire, or deliver their power strokes, beginning with the number one cylinder.

**Flywheel** A heavy spinning wheel in which energy is absorbed and stored by means of momentum. On cars, the flywheel is attached to the crankshaft to smooth out firing impulses.

**Free play** The amount of travel before any action takes place. The "looseness" in a linkage, or an assembly of parts, between the initial application of force and actual movement. For example, the distance the brake pedal moves before the pistons in the master cylinder are actuated.

**Fuse** An electrical device which protects a circuit against accidental overload. The typical fuse contains a soft piece of metal which is calibrated to melt at a predetermined current flow (expressed as amps) and break the circuit.

**Fusible link** A circuit protection device consisting of a conductor surrounded by heat-resistant insulation. The conductor is smaller than the wire it protects, so it acts as the weakest link in the circuit. Unlike a blown fuse, a failed fusible link must frequently be cut from the wire for replacement.

**G**

**Gap** The distance the spark must travel in jumping from the centre electrode to the side

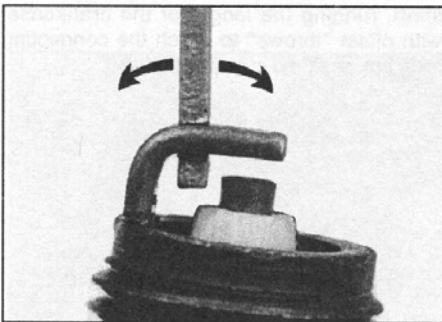

Adjusting spark plug gap

electrode in a spark plug. Also refers to the spacing between the points in a contact breaker assembly in a conventional points-type ignition, or to the distance between the reluctor or rotor and the pickup coil in an electronic ignition.

**Gasket** Any thin, soft material - usually cork, cardboard, asbestos or soft metal - installed between two metal surfaces to ensure a good seal. For instance, the cylinder head gasket seals the joint between the block and the cylinder head.

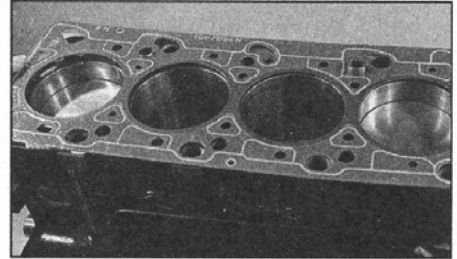

Gasket

**Gauge** An instrument panel display used to monitor engine conditions. A gauge with a movable pointer on a dial or a fixed scale is an analogue gauge. A gauge with a numerical readout is called a digital gauge.

**H**

**Halfshaft** A rotating shaft that transmits power from the final drive unit to a drive wheel, usually when referring to a live rear axle.

**Harmonic balancer** A device designed to reduce torsion or twisting vibration in the crankshaft. May be incorporated in the crankshaft pulley. Also known as a vibration damper.

**Hone** An abrasive tool for correcting small irregularities or differences in diameter in an engine cylinder, brake cylinder, etc.

**Hydraulic tappet** A tappet that utilises hydraulic pressure from the engine's lubrication system to maintain zero clearance (constant contact with both camshaft and valve stem). Automatically adjusts to variation in valve stem length. Hydraulic tappets also reduce valve noise.

**I**

**Ignition timing** The moment at which the spark plug fires, usually expressed in the number of crankshaft degrees before the piston reaches the top of its stroke.

**Inlet manifold** A tube or housing with passages through which flows the air-fuel mixture (carburettor vehicles and vehicles with throttle body injection) or air only (port fuel-injected vehicles) to the port openings in the cylinder head.

**J**  
**Jump start** Starting the engine of a vehicle with a discharged or weak battery by attaching jump leads from the weak battery to a charged or helper battery.

**L**  
**Load Sensing Proportioning Valve (LSPV)** A brake hydraulic system control valve that works like a proportioning valve, but also takes into consideration the amount of weight carried by the rear axle.

**Locknut** A nut used to lock an adjustment nut, or other threaded component, in place. For example, a locknut is employed to keep the adjusting nut on the rocker arm in position.

**Lockwasher** A form of washer designed to prevent an attaching nut from working loose.

**M**  
**MacPherson strut** A type of front suspension system devised by Earle MacPherson at Ford of England. In its original form, a simple lateral link with the anti-roll bar creates the lower control arm. A long strut - an integral coil spring and shock absorber - is mounted between the body and the steering knuckle. Many modern so-called MacPherson strut systems use a conventional lower A-arm and don't rely on the anti-roll bar for location.  
**Multimeter** An electrical test instrument with the capability to measure voltage, current and resistance.

**N**  
**NOx** Oxides of Nitrogen. A common toxic pollutant emitted by petrol and diesel engines at higher temperatures.

**O**  
**Ohm** The unit of electrical resistance. One volt applied to a resistance of one ohm will produce a current of one amp.  
**Ohmmeter** An instrument for measuring electrical resistance.  
**O-ring** A type of sealing ring made of a special rubber-like material; in use, the O-ring is compressed into a groove to provide the sealing action.



O-ring

**Overhead cam (ohc) engine** An engine with the camshaft(s) located on top of the cylinder head(s).

**Overhead valve (ohv) engine** An engine with the valves located in the cylinder head, but with the camshaft located in the engine block.

**Oxygen sensor** A device installed in the engine exhaust manifold, which senses the oxygen content in the exhaust and converts this information into an electric current. Also called a Lambda sensor.

**P**  
**Phillips screw** A type of screw head having a cross instead of a slot for a corresponding type of screwdriver.

**Plastigage** A thin strip of plastic thread, available in different sizes, used for measuring clearances. For example, a strip of Plastigage is laid across a bearing journal. The parts are assembled and dismantled; the width of the crushed strip indicates the clearance between journal and bearing.



Plastigage

**Propeller shaft** The long hollow tube with universal joints at both ends that carries power from the transmission to the differential on front-engined rear wheel drive vehicles.

**Proportioning valve** A hydraulic control valve which limits the amount of pressure to the rear brakes during panic stops to prevent wheel lock-up.

**R**  
**Rack-and-pinion steering** A steering system with a pinion gear on the end of the steering shaft that mates with a rack (think of a geared wheel opened up and laid flat). When the steering wheel is turned, the pinion turns, moving the rack to the left or right. This movement is transmitted through the track rods to the steering arms at the wheels.

**Radiator** A liquid-to-air heat transfer device designed to reduce the temperature of the coolant in an internal combustion engine cooling system.

**Refrigerant** Any substance used as a heat transfer agent in an air-conditioning system. R-12 has been the principle refrigerant for many years; recently, however, manufacturers have begun using R-134a, a non-CFC substance that is considered less harmful to the ozone in the upper atmosphere.

**Rocker arm** A lever arm that rocks on a shaft or pivots on a stud. In an overhead valve engine, the rocker arm converts the upward movement of the pushrod into a downward movement to open a valve.

**Rotor** In a distributor, the rotating device inside the cap that connects the centre electrode and the outer terminals as it turns, distributing the high voltage from the coil secondary winding to the proper spark plug. Also, that part of an alternator which rotates inside the stator. Also, the rotating assembly of a turbocharger, including the compressor wheel, shaft and turbine wheel.

**Runout** The amount of wobble (in-and-out movement) of a gear or wheel as it's rotated. The amount a shaft rotates "out-of-true." The out-of-round condition of a rotating part.

**S**  
**Sealant** A liquid or paste used to prevent leakage at a joint. Sometimes used in conjunction with a gasket.

**Sealed beam lamp** An older headlight design which integrates the reflector, lens and filaments into a hermetically-sealed one-piece unit. When a filament burns out or the lens cracks, the entire unit is simply replaced.

**Serpentine drivebelt** A single, long, wide accessory drivebelt that's used on some newer vehicles to drive all the accessories, instead of a series of smaller, shorter belts. Serpentine drivebelts are usually tensioned by an automatic tensioner.

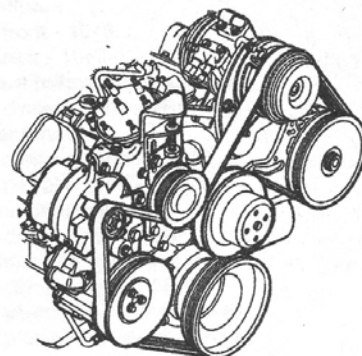

Serpentine drivebelt

**Shim** Thin spacer, commonly used to adjust the clearance or relative positions between two parts. For example, shims inserted into or under bucket tappets control valve clearances. Clearance is adjusted by changing the thickness of the shim.

**Slide hammer** A special puller that screws into or hooks onto a component such as a shaft or bearing; a heavy sliding handle on the shaft bottoms against the end of the shaft to knock the component free.

**Sprocket** A tooth or projection on the periphery of a wheel, shaped to engage with a chain or drivebelt. Commonly used to refer to the sprocket wheel itself.

**Starter inhibitor switch** On vehicles with an automatic transmission, a switch that prevents starting if the vehicle is not in Neutral or Park.

**Strut** See MacPherson strut.

## T

**Tappet** A cylindrical component which transmits motion from the cam to the valve stem, either directly or via a pushrod and rocker arm. Also called a cam follower.

**Thermostat** A heat-controlled valve that regulates the flow of coolant between the cylinder block and the radiator, so maintaining optimum engine operating temperature. A thermostat is also used in some air cleaners in which the temperature is regulated.

**Thrust bearing** The bearing in the clutch assembly that is moved in to the release levers by clutch pedal action to disengage the clutch. Also referred to as a release bearing.

**Timing belt** A toothed belt which drives the camshaft. Serious engine damage may result if it breaks in service.

**Timing chain** A chain which drives the camshaft.

**Toe-in** The amount the front wheels are closer together at the front than at the rear. On rear wheel drive vehicles, a slight amount of toe-in is usually specified to keep the front wheels running parallel on the road by offsetting other forces that tend to spread the wheels apart.

**Toe-out** The amount the front wheels are closer together at the rear than at the front. On front wheel drive vehicles, a slight amount of toe-out is usually specified.

**Tools** For full information on choosing and using tools, refer to the *Haynes Automotive Tools Manual*.

**Tracer** A stripe of a second colour applied to a wire insulator to distinguish that wire from another one with the same colour insulator.

**Tune-up** A process of accurate and careful adjustments and parts replacement to obtain the best possible engine performance.

**Turbocharger** A centrifugal device, driven by exhaust gases, that pressurises the intake air. Normally used to increase the power output from a given engine displacement, but can also be used primarily to reduce exhaust emissions (as on VW's "Umwelt" Diesel engine).

## U

**Universal joint or U-joint** A double-pivoted connection for transmitting power from a driving to a driven shaft through an angle. A U-joint consists of two Y-shaped yokes and a cross-shaped member called the spider.

## V

**Valve** A device through which the flow of liquid, gas, vacuum, or loose material in bulk

may be started, stopped, or regulated by a movable part that opens, shuts, or partially obstructs one or more ports or passageways. A valve is also the movable part of such a device.

**Valve clearance** The clearance between the valve tip (the end of the valve stem) and the rocker arm or tappet. The valve clearance is measured when the valve is closed.

**Vernier caliper** A precision measuring instrument that measures inside and outside dimensions. Not quite as accurate as a micrometer, but more convenient.

**Viscosity** The thickness of a liquid or its resistance to flow.

**Volt** A unit for expressing electrical "pressure" in a circuit. One volt that will produce a current of one ampere through a resistance of one ohm.

## W

**Welding** Various processes used to join metal items by heating the areas to be joined to a molten state and fusing them together. For more information refer to the *Haynes Automotive Welding Manual*.

**Wiring diagram** A drawing portraying the components and wires in a vehicle's electrical system, using standardised symbols. For more information refer to the *Haynes Automotive Electrical and Electronic Systems Manual*.

**Note:** References through-out this index are in the form - "Chapter number" • "Page number"

## A

**Accelerator cable** - 4A•2, 4B•3, 4C•4  
**Accelerator mechanism**  
 diesel models - 1B•13  
 petrol models - 1A•14  
**Accelerator pedal** - 4A•3, 4B•4, 4C•4  
**Accessory shops** - REF•3  
**Acknowledgements** - 0•4  
**Aerial and amplifier** - 13•24  
**Air bags** - 0•5  
**Air cleaner dump valve**  
 diesel models - 1B•11  
**Air conditioning compressor drivebelt**  
 diesel models - 1B•12, 1B•13  
 petrol models - 1A•16, 1A•17  
**Air conditioning system** - 3•6, 3•12, 3•13, 13•8  
**Air distribution housing** - 3•9  
**Air filter**  
 diesel models - 1B•9, 4C•4  
 petrol models - 1A•11, 4A•2, 4B•2  
**Air recirculation flap system** - 3•12  
**Air recirculation switch** - 13•8  
**Air temperature sensor** - 4C•14  
**Airbag system** - 13•24  
 diesel models - 1B•22  
 petrol models - 1A•30  
**Airflow sensor** - 4B•4, 4C•13  
**Airlocks**  
 diesel models - 1B•21  
 petrol models - 1A•28  
**Alternator** - 5A•3, 5A•4  
 drivebelt  
 diesel models - 1B•11, 1B•12  
 petrol models - 1A•15, 1A•16  
**Antifreeze**  
 diesel models - 1B•21  
 petrol models - 1A•27  
**Anti-lock braking system (ABS)** - 10•14  
**Anti-roll bar connecting link**  
 front - 11•7  
 rear - 11•10  
**Anti-roll bar**  
 front - 11•6  
 rear - 11•10  
**Anti-theft alarm system** - 13•26  
**Asbestos** - 0•5  
**ATF** - 0•17  
 diesel models - 1B•8, 1B•20  
 petrol models - 1A•8, 1A•26  
**Automatic transmission** - 7B•1 et seq

fault finding - REF•18  
**Automatic transmission fluid** - 0•17  
 diesel models - 1B•8, 1B•20  
 petrol models - 1A•8, 1A•26  
**Automatic transmission fluid oil screen**  
 diesel models - 1B•20  
 petrol models - 1A•26  
**Automatic transmission selector panel**  
 bulb - 13•13  
**Auxiliary drivebelt**  
 diesel models - 1B•11  
 petrol models - 1A•15  
**Auxiliary light**  
 diesel models - 1B•18  
 petrol models - 1A•24  
**Axle breather**  
 diesel models - 1B•16  
 petrol models - 1A•22  
**Axle**  
 front - 9•11  
 rear - 9•15  
**Axle halfshaft**  
 front - 9•3  
 rear - 9•12  
**Axle oil** - 0•17  
 diesel models - 1B•14  
 petrol models - 1A•20, 1A•25  
**Axle swivel pin housing** - 9•9

## B

**Badges** - 12•17  
**Balljoint** - 11•18  
**Battery** - 0•5, 0•15, 5A•2, 5A•3, 13•4  
 electrolyte  
 diesel models - 1B•8  
 petrol models - 1A•7  
**Big-end bearings** - 2C•24  
 running clearance check - 2C•28  
**Bleeding**  
 diesel fuel system - 4C•4  
 brakes - 10•2  
 clutch - 6•6  
 power steering system - 11•16  
**Body corrosion** - REF•13  
**Body electrical systems** - 13•1 et seq  
**Body under-panels** - 12•17  
**Bodywork and fittings** - 12•1 et seq  
**Bonnet** - 12•4  
 lock - 12•5  
 release cable - 12•5  
**Brake fluid** - 0•13, 0•17

diesel models - 1B•20  
 petrol models - 1A•26  
**Brake pedal switch** - 4C•13  
**Brake vacuum servo** - 10•10  
 diesel models - 1B•10, 1B•21  
 petrol models - 1A•15, 1A•28  
**Braking system** - 10•1 et seq, REF•12  
 diesel models - 1B•18  
 fault finding - REF•20  
 petrol models - 1A•24  
**Breather**  
 axle  
 diesel models - 1B•16  
 petrol models - 1A•22  
 crankcase  
 diesel models - 1B•10, 1B•11  
 petrol models - 1A•12  
**Bulbs** - 0•15, 13•9, 13•11  
**Bump stop**  
 front - 11•7  
 rear - 11•11  
**Bumpers** - 12•4  
**Burning** - 0•5  
**Buying spare parts** - REF•3  
**By-pass air valve** - 4B•5

## C

**Cable**  
 accelerator - 4A•2, 4B•3, 4C•4  
 bonnet release - 12•5  
 choke - 4A•3  
 handbrake - 10•11  
 kickdown - 7B•3  
 speedometer - 13•18  
**Calipers**  
 front - 10•6  
 rear - 10•7  
**Cam follower components**  
 diesel engine - 2B•16  
**Camshaft**  
 diesel engine - 2C•15  
 petrol engine - 2A•11  
**Camshaft oil seal**  
 diesel engine - 2B•21  
**Camshaft sprocket**  
 diesel engine - 2B•9  
**Carburettors** - 4A•3, 4A•5  
 piston damper oil - 1A•13  
**Carpets** - 12•2, 12•20  
**Cassette player** - 13•22  
 anti-theft system - precaution - REF•7

**Catalytic converter** - 4D•9  
diesel models - 1B•22

**CD player** - 13•22

**Central locking** - 12•14

**Centre console** - 12•20  
switches - 13•7

**Charcoal canister**  
petrol models - 1A•29

**Charging** - 5A•2, 5A•3

**Choke cable** - 4A•3

**Cigarette lighter** - 13•18  
illumination bulb - 13•12, 13•13

**Circuit board** - 13•17

**Clock** - 13•17  
illumination bulb - 13•12, 13•13

**Clutch** - 6•1 *et seq*  
fault finding - REF•17

**Clutch fluid**  
diesel models - 1B•8  
petrol models - 1A•8

**Clutch pedal switch** - 4C•13

**Coil** - 5B•2

**Coil spring**  
front - 11•5  
rear - 11•8

**Compression test**  
diesel engine - 2B•4  
petrol engine - 2A•3

**Connecting rod assembly** - 2C•18, 2C•22, 2C•28

**Console** - 12•20  
switches - 13•7

**Constant velocity joint** - 9•3

**Contents** - 0•2

**Conversion factors** - REF•2

**Coolant** - 0•12, 0•17  
diesel models - 1B•20  
petrol models - 1A•27

**Coolant pump** - 3•7  
drivebelt  
diesel models - 1B•11, 1B•12

**Coolant temperature**  
gauge - 13•16  
sender - 4B•6

**Cooling fan drivebelt**  
diesel models - 1B•11, 1B•12

**Cooling, heating and ventilation systems** - 3•1 *et seq*  
diesel models - 1B•10  
fault finding - REF•17  
petrol models - 1A•14

**Courtesy light** - 13•11  
switches - 13•8

**Crankcase breather**  
diesel models - 1B•11, 1B•10  
petrol models - 1A•12

**Crankcase emission control** - 4D•1, 4D•2

**Crankshaft** - 2C•20, 2C•24, 2C•25

**Crankshaft oil seal**  
diesel engine - 2B•20  
petrol engine - 2A•14, 2A•15

**Crankshaft pulley**  
diesel engine - 2B•6

**Crankshaft spigot bush**  
diesel engine - 2B•23

**Crankshaft sprocket**  
diesel engine - 2B•10

**Cruise control system** - 4B•15, 4C•15

**Crushing** - 0•5

**Cup holder** - 12•19

**Cylinder block/crankcase** - 2C•21

**Cylinder head** - 2C•15, 2C•16, 2C•18  
diesel engine - 2B•14  
petrol engine - 2A•11

## D

**Dents in the vehicle's bodywork** - 12•2

**Depressurisation**  
carburettor fuel system - 4A•3  
fuel injection system - 4B•4

**Diesel engine in-car repair procedures** - 2B•1 *et seq*

**Diesel injection equipment** - 0•5

**Differential** - 9•15

**Dim-dip lighting system** - 13•26

**Dimensions** - REF•1

**Direction indicators** - 13•10, 13•14

**Discs** - 10•5, 10•6  
diesel models - 1B•18  
petrol models - 1A•24

**Distributor** - 1A•10, 5B•3, 5B•4

**Doors** - 12•5, 12•6, 12•7, 12•10, REF•11

**Door edge light** - 13•11

**Door switches** - 13•7

**Drag link** - 11•17

**Drivebelt**  
air conditioning compressor  
diesel models - 1B•12, 1B•13  
petrol models - 1A•16, 1A•17  
alternator  
diesel models - 1B•11, 1B•12  
petrol models - 1A•15, 1A•16  
coolant pump  
diesel models - 1B•11, 1B•12  
cooling fan  
diesel models - 1B•11, 1B•12  
power steering pump  
diesel models - 1B•11, 1B•12  
petrol models - 1A•15  
water pump  
petrol models - 1A•16, 1A•17

**Driveplate**  
diesel engine - 2B•22  
petrol engine - 2A•17

**Driveshafts** - REF•12

**Drivetrain**  
diesel models - 1B•17  
petrol models - 1A•23

**Dump valve**  
diesel models - 1B•11

## E

**Earth fault** - 13•5

**Electric seats**  
switches - 13•9

**Electric shock** - 0•5

**Electric windows** - 12•15  
switches - 13•7  
illumination bulbs - 13•13

**Electrical equipment** - REF•11  
diesel models - 1B•17  
petrol models - 1A•23

**Electrical system**  
fault finding - 13•4, REF•22, REF•23

**Electrolyte**  
diesel models - 1B•8  
petrol models - 1A•7

**Electronic control unit (ECU)**  
anti-lock braking system (ABS) - 10•14  
fuel injection - 4B•6  
Electronic Diesel Control (EDC) - 4C•14  
exhaust gas recirculation - 4D•3

**Electronic Diesel Control (EDC) system** - 4C•12, 4C•13

**Emission control systems** - 4D•1, REF•13  
petrol models - 1A•29

**Engine**  
fault finding - REF•15, REF•16

**Engine oil** - 0•12, 0•17,  
diesel models - 1B•7  
petrol oil - 1A•6

**Engine removal and overhaul procedures** - 2C•1 *et seq*

**Engine speed sensor** - 4C•13

**Engine will not start** - 5B•2

**Environmental considerations** - REF•4

**Evaporative emission control** - 4D•2  
petrol models - 1A•28

**Exhaust and emission control systems** - 4D•1 *et seq*

**Exhaust gas recirculation (EGR) system** - 4D•3

**Exhaust manifold** - 4D•4

**Exhaust specialists** - REF•3

**Exhaust system** - 4D•2, 4D•6, REF•12, REF•13  
diesel models - 1B•15  
petrol models - 1A•22

**Exterior light units** - 13•13

**F**

**Facia panel** - 12•21  
switches - 13•8

**Fan and viscous coupling** - 3•5

**Fault finding** - REF•14 *et seq*  
automatic transmission - REF•18  
braking system - REF•20  
clutch - REF•17  
cooling system - REF•17  
electrical system - 13•4, REF•22, REF•23  
engine - REF•15, REF•16  
front and rear axles - REF•9  
fuel and exhaust systems - REF•17  
manual transmission - REF•18  
propeller shafts - REF•19  
suspension and steering - REF•21  
transfer gearbox - REF•19

**Filling** - 12•3

**Filters**  
air - 4A•2, 4B•2, 4C•4  
diesel models - 1B•9  
petrol models - 1A•111  
crankcase breather  
diesel models - 1B•10  
fuel  
diesel models - 1B•9  
petrol models - 1A•28  
oil  
diesel models - 1B•7  
petrol models - 1A•6  
servo  
diesel models - 1B•21  
petrol models - 1A•28

**Fire** - 0•5

**Fluids** - 0•17

**Flywheel**  
diesel engine - 2B•22  
housing  
diesel models - 1B•15  
petrol models - 1A•23  
petrol engine - 2A•16

**Footbrake** - REF•10, REF•11

**Front and rear axles** - 9•1 *et seq*  
fault finding - REF•9

**Fuel and exhaust systems**  
fault finding - REF•17

**Fuel filter**  
diesel models - 1B•9  
petrol models - 1A•28

**Fuel gauge** - 13•16, 13•17  
sender unit - 4A•7, 4B•12, 4C•5

**Fuel injection pump** - 4C•6  
sprocket - 2B•10

**Fuel lift pump** - 4C•5

**Fuel pressure regulator** - 4B•9

**Fuel pump** - 4A•7, 4B•12

**Fuel rail and injectors** - 4B•10

**Fuel sedimenter**

diesel models - 1B•16

**Fuel system** -  
*carburettor models* - 4A•1 *et seq*  
**Fuel system - diesel** - 4C•1 *et seq*  
**Fuel system** -  
*petrol injection models* - 4B•1 *et seq*  
**Fuel system** - REF•13

**Fuel tank** - 4A•7, 4B•12, 4C•5  
diesel models - 1B•16  
petrol models - 1A•23

**Fuel temperature sensor** - 4C•14

**Fuel temperature thermistor** - 4B•6

**Fume or gas intoxication** - 0•5

**Fuses** - 0•15, 13•5

**G**

**Gaiter**  
propeller shaft - 8•4

**Gashes in the vehicle's bodywork** - 12•3

**Gaskets** - REF•4

**Gear selector interlock solenoid** - 7B•3

**General repair procedures** - REF•4

**Glossary of technical terms** - REF•24 *et seq*

**Glovebox** - 12•19  
illumination bulb - 13•12  
illumination switch - 13•9

**Glow plugs** - 1B•10, 5C•2

**Grille** - 12•23

**H**

**Halfshaft**  
front - 9•3  
rear - 9•12

**Handbrake** - 10•10, 10•11, REF•10  
diesel models - 1B•16  
linkage  
diesel models - 1B•15  
petrol models - 1A•21  
petrol models - 1A•23  
warning light switch - 13•7

**Handles** - 12•7

**Hazard warning light switch** - 13•7  
bulb - 13•13

**Headlight** - 13•9, 13•14  
beam alignment - 13•15  
diesel models - 1B•18  
levelling system - 13•26  
switch - 13•8  
petrol models - 1A•24  
washer system - 13•21

**Headlining** - 12•20

**Heated seat switches** - 13•9  
illumination bulbs - 13•13

**Heater** - 3•8, 3•10, 3•11, 3•12  
blower motor switch - 13•8  
control panel illumination bulb - 13•12  
diesel models - 1B•10

petrol models - 1A•14

**Heatshields** - 4D•7

**High-level stop-light** - 13•11, 13•15

**Hinges**  
diesel models - 1B•18  
petrol models - 1A•24

**Holes in the vehicle's bodywork** - 12•3

**Horn** - 13•18

**Hoses**  
diesel models - 1B•15  
petrol models - 1A•21

**HT leads** - 1A•9

**Hub assembly**  
front - 9•3  
rear - 9•13

**Hub bearing**  
front - 9•7  
rear - 9•14

**Hydraulic damper**  
clutch - 6•5

**Hydraulic pipes and hoses** - 10•3

**Hydrofluoric acid** - 0•5

**I**

**Idle speed** - 4B•14, 4C•6  
diesel models - 1B•8  
petrol models - 1A•13

**Idler pulley**  
diesel engine - 2B•11

**Ignition coil** - 5B•2

**Ignition switch** - 11•12  
wiring block - 11•13

**Ignition system - petrol engines** - 1A•9,  
5B•1 *et seq*

**Ignition timing** - 1A•25

**Indicators** - 13•10, 13•14

**Inertia switch** - 4B•7

**Injection timing** - 4C•8  
sensor - 4C•13

**Injectors** - 4B•10, 4C•9

**Inlet manifold** - 4A•6, 4B•12, 4C•11

**Instrument panel** - 13•15, 13•16  
illumination/warning lights - 13•12  
surround switches - 13•7  
illumination bulbs - 13•13

**Instruments**  
diesel models - 1B•17  
petrol models - 1A•23

**Intercooler** - 1B•21, 4C•10

**J**

**Jack and tools**  
diesel models - 1B•13  
petrol models - 1A•19

**Jacking and vehicle support** - REF•6

**Joint mating faces** - REF•4

**Jump starting** - 0•7

**K**

Kickdown cable - 7B•3

**L**

Lambda sensors - 4D•2

Leakdown test

diesel engine - 2B•4

Leaks - 0•10

'Lights-on' warning system - 13•17

Locknuts, locktabs and washers - REF•4

Locks

bonnet - 12•5

diesel models - 1B•18

doors - 12•7

petrol models - 1A•24

tailgate - 12•12

Lubricants and fluids - 0•17

Luggage compartment light - 13•12

**M**

Main bearings - 2C•24

running clearance check - 2C•25

Maintenance procedures

diesel models - 1B•6

petrol models - 1A•5

Maintenance schedule

diesel models - 1B•3

petrol models - 1A•3

Manifolds - 4A•6, 4B•12, 4C•11, 4D•4

Manual transmission - 7A•1 *et seq*

fault finding - REF•18

Manual transmission fluid - 0•17

diesel models - 1B•13

petrol models - 1A•19

Master cylinder

brakes - 10•8

clutch - 6•5

Maximum speed - 4C•5

Mirrors - 12•15, REF•10

switch - 13•7

Misfire - 5B•2

Mixture check

petrol models - 1A•13

Modulator assembly - 10•14

MOT test checks - REF•10 *et seq*

Mountings

diesel engine - 2B•23

petrol engine - 2A•18

**N**

Number plate light - 13•11, 13•15

**O**

Oil

automatic transmission - 0•17

diesel models - 1B•8

petrol models - 1A•8, 1A•26

axle - 0•17

diesel models - 1B•14, 1B•19

petrol models - 1A•20, 1A•25

carburettor piston damper - 1A•13

engine - 0•12, 0•17

diesel models - 1B•7

petrol models - 1A•6

manual transmission - 0•17

diesel models - 1B•13

petrol models - 1A•19

swivel pin housing - 0•17

diesel models - 1B•14, 1B•19

petrol models - 1A•20, 1A•26

transfer gearbox - 0•17

diesel models - 1B•14, 1B•19

petrol models - 1A•20, 1A•25

Oil cooler

diesel engine - 2B•24

petrol engine - 2A•20

Oil filter

diesel models - 1B•7

petrol models - 1A•6

Oil pressure warning light switch

diesel engine - 2B•24

petrol engine - 2A•20

Oil pump

diesel engine - 2B•19

petrol engine - 2A•19

Oil seals - REF•4

diesel engine - 2B•20

petrol engine - 2A•14, 2A•15

valve stems - 2C•18

Open-circuit - 13•5

**P**

Pads

diesel models - 1B•18

front - 10•3

petrol models - 1A•24

rear - 10•5

Panhard rod - 11•6

Pedals

accelerator - 4A•3, 4B•4, 4C•4

brake - 4C•13, 10•9

clutch - 4C•13, 6•7

Petrol engine in-car repair

procedures - 2A•1 *et seq*

Pick-up coil - 5B•2

Pipes

diesel models - 1B•15

petrol models - 1A•21

Piston/connecting rod assembly - 2C•18,

2C•22, 2C•28

Plastic components - 12•3

Plenum chamber - 4B•7

ventilation duct - petrol models - 1A•26

Poisonous or irritant substances - 0•5

Power steering fluid - 0•13, 0•17

Power steering pump - 11•16

drivebelt

diesel models - 1B•11, 1B•12

petrol models - 1A•15

Power steering system - bleeding - 11•16

Pre-heating system -

diesel models - 5C•1 *et seq*

Pressure-regulating valve - 10•13

Priming

diesel fuel system - 4C•4

Printed circuit - 13•16, 13•17

Propeller shafts - 8•1 *et seq*

diesel models - 1B•16

petrol models - 1A•22

fault finding - REF•19

joint

diesel models - 1B•14

grease - 0•17

petrol models - 1A•21

Puncture repair - 0•8, 1A•19

Pushrods petrol engine - 2A•10

**R**

Radiator - 3•2

grille - 12•23

Radio - 13•22

anti-theft system - precaution - REF•7

Radius arm - 11•6

Ram housing - 4B•9

Rear light cluster - 13•11, 13•14

Regulator

window - 12•10

Relays - 13•6

fuel injection - 4B•6

Release bearing - 6•3

Release lever - 6•3

Repair procedures - REF•4

Respraying - 12•3

Reversing light switch - 7A•2, 7B•3

Road test

diesel models - 1B•17

petrol models - 1A•23

Roadside repairs - 0•6

Rocker covers

petrol engine - 2A•7

Rocker gear

diesel engine - 2B•11

petrol engine - 2A•9

Rotor arm - 1A•10

Routine maintenance &amp; servicing -

diesel models - 1B•1 *et seq*

Routine maintenance &amp; servicing -

petrol models - 1A•1 *et seq*

Routine maintenance

bodywork and underframe - 12•1

upholstery and carpets - 12•2

**S**

Safety first! - 0•5, 0•13

Scalding - 0•5

Scratches in the vehicle's bodywork - 12•2

Screw threads and fastenings - REF•4

Seat belts - 12•18

diesel models - 1B•18

petrol models - 1A•24

Seats - 12•17

switches - 13•9

illumination bulbs - 13•13

Sedimenter

diesel models - 1B•16

Selector assembly - 7B•1

Servo - 10•10

diesel models - 1B•10, 1B•21

petrol models - 1A•15, 1A•28

Shock absorbers - REF•11, REF•12

diesel models - 1B•21

front - 11•4

petrol models - 1A•28

rear - 11•8



**Shoes** - 10•10  
**Short-circuit** - 13•5  
**Sidelights** - 13•10, 13•11  
**Slave cylinder**  
 clutch - 6•4  
**Spare parts** - REF•3  
**Spare wheel**  
 diesel models - 1B•18  
 petrol models - 1A•24  
**Spark plugs** - 1A•8  
**Speakers** - 13•23  
**Speed sensor** - 4B•5, 4C•13  
**Speedometer** - 13•16  
 drive cable - 13•18  
**Springs** - REF•12  
**Starter inhibitor/reversing light switch** - 7B•3  
**Starter motor** - 5A•5, 5A•6  
**Starting and charging systems** - 5A•1 *et seq*  
**Start-up after overhaul** - 2C•30  
**Steering** - 11•14, REF•11, REF•12  
 angles - 11•18  
 box - 11•14  
 drop arm - 11•15  
 column - 11•13, REF•10  
 combination switches - 13•6  
 intermediate shaft - 11•14  
 switch illumination bulb - 13•13  
 universal joint - 11•14  
 damper - 11•16  
 diesel models - 1B•15, 1B•17  
 fault finding - REF•21  
 gear  
 diesel models - 1B•13  
 petrol models - 1A•19  
 petrol models - 1A•22, 1A•23  
 wheel - 11•11, REF•10  
**Stop solenoid** - 5C•3  
**Stop-light** - 13•11, 13•15  
 switch - 10•13  
**Stub axle**  
 front - 9•8  
 rear - 9•14  
**Sump**  
 diesel engine - 2B•16  
 petrol engine - 2A•18  
**Sunroof** - 12•17  
 diesel models - 1B•18  
 petrol models - 1A•24  
 switch - 13•8  
**Suspension and steering** - 11•1 *et seq*,  
 REF•11, REF•12  
 fault finding - REF•21  
**Suspension**  
 bump stop  
 front - 11•7  
 rear - 11•11  
 diesel models - 1B•15, 1B•17  
 petrol models - 1A•22, 1A•23  
**Switches** - 13•6  
 air conditioning system fan temperature - 3•6  
 illumination bulbs - 13•13  
 brake pedal - 4C•13  
 clutch pedal - 4C•13  
 cooling system - 3•6  
 oil pressure warning light

diesel engine - 2B•24  
 petrol engine - 2A•20  
 reversing light - 7A•2, 7B•3  
 stop-light - 10•13  
**Swivel pin housing oil** - 0•17  
 diesel models - 1B•14, 1B•19  
 petrol models - 1A•20, 1A•26

## T

**Tachometer** - 13•16  
**Tailgate** - 12•11, 12•12, 12•16  
 washer system - 13•20  
 wiper motor - 13•20  
**Tappets**  
 petrol engine - 2A•10  
**Temperature gauge** - 13•16  
 sender - 3•6, 4B•6, 4C•14, 4D•3  
**Temperature switch**  
 air conditioning system - 3•6  
**Thermostat** - 3•3  
 diesel engine - 2B•24  
**Throttle position sensor** - 4C•14, 4D•3  
**Throttle potentiometer** - 4B•5  
**Timing belt** - 2B•8, 1B•21  
 cover - 2B•7  
 housing - 1B•16, 2B•21  
 sprockets and tensioner - 2B•9, 2B•11  
**Timing cover, chain and gears** - 2A•4, 2A•15  
**Tools and working facilities** - REF•8 *et seq*,  
 REF•4  
**Top dead centre (TDC) for No 1 piston** -  
 locating  
 diesel engine - 2B•4  
 petrol engine - 2A•4  
**Towing** - 0•10  
 bracket  
 diesel models - 1B•16  
 petrol models - 1A•23  
**Track rod** - 11•18  
**Transfer gearbox** - 7C•1 *et seq*  
 fault finding - REF•19  
 oil - 0•17  
 diesel models - 1B•14, 1B•19  
 petrol models - 1A•20, 1A•25  
**Trim panels** - 12•6, 12•17, 12•19  
**Turbocharger** - 4C•10  
 boost pressure  
 diesel models - 1B•20  
 sensor - 4C•14  
**Tyres** - REF•13  
 condition and pressure - 0•14  
 pressures (cold) - 0•18  
 specialists - REF•3

## U

**Underbody component, pipe, hose and wiring check**  
 diesel models - 1B•15  
 petrol models - 1A•21  
**Underframe** - 12•1  
**Under-panels** - 12•17  
**Unleaded petrol** - 4A•8, 4B•15  
**Upholstery** - 12•2  
**Upper link** - 11•9  
 balljoint - 11•10

## V

**Vacuum pump**  
 diesel models - 10•14  
**Servo** - 10•10  
 diesel models - 1B•10, 1B•21  
 petrol models - 1A•15, 1A•28  
**Valve clearances**  
 diesel models - 1B•7  
**Valve cover**  
 diesel engine - 2B•5  
**Valve gear**  
 diesel engine - 2B•11  
 petrol engine - 2A•8  
**Valve springs** - 2C•17  
**Valve stems**  
 caps - 2C•18  
 oil seals - 2C•18  
**Valves** - 2C•17  
**Vehicle identification numbers** - REF•5, REF•11  
**Vehicle support** - REF•6  
**Ventilation system** - 3•8, 3•12  
**Vents** - 3•12  
**Viscous coupling** - 3•5

## W

**Warning light bulb** - 13•25  
**Warning light panel** - 13•16  
**Warning lights** - 13•12  
**Washer fluid** - 0•16  
**Washer jets** - 13•21, 13•22  
**Washer pump** - 13•21  
**Washer systems** - 13•20, 13•21  
**Water pump drivebelt**  
 petrol models - 1A•16, 1A•17  
**Weekly checks** - 0•11 *et seq*  
**Weights** - REF•1  
**Wheel alignment** - 11•18  
 diesel models - 1B•18  
 petrol models - 1A•24  
**Wheel arch liners** - 12•17  
**Wheel bearings** - REF•12  
**Wheel changing** - 0•8, 1A•19  
**Wheel sensor** - 10•14  
**Wheels** - REF•13  
**Window glass** - 12•10  
**Window switches** - 13•7  
 illumination bulbs - 13•13  
**Windows** - 12•15, 12•16  
**Windscreen** - 12•16, REF•10  
**Windscreen washer system** - 13•20  
**Windscreen wiper motor and linkage** - 13•19  
**Wiper arm** - 13•18  
**Wiper blades** - 0•16  
**Wiper motor tailgate** - 13•20  
**Wiper motor windscreen** - 13•19  
**Wiring diagrams** - 13•27 *et seq*  
**Wiring**  
 diesel models - 1B•15  
 petrol models - 1A•21  
**Working facilities** - REF•8 *et seq*  
**Your Discovery manual** - 0•4

# Haynes Manuals - The Complete List

Title	Book No.	Title	Book No.	Title	Book No.
<b>ALFA ROMEO</b> Alfasud/Sprint (74 - 88) up to F *	<b>0292</b>	Ford Capri II (& III) 1.6 & 2.0 (74 - 87) up to E *	<b>0283</b>	Mazda RX-7 (79 - 85) up to C *	<b>0460</b>
Alfa Romeo Alfetta (73 - 87) up to E *	<b>0531</b>	Ford Capri II (& III) 2.8 & 3.0 V6 (74 - 87) up to E	<b>1309</b>	<b>MERCEDES-BENZ</b> 190, 190E & 190D Petrol & Diesel (83 - 93) A to L	<b>3450</b>
<b>AUDI</b> 80, 90 & Coupe Petrol (79 - Nov 88) up to F	<b>0605</b>	Ford Cortina Mk III 1300 & 1600 (70 - 76) up to P *	<b>0070</b>	Mercedes-Benz 200D, 240D, 240TD, 300D & 300TD 123 Series Diesel (Oct 76 - 85) up	<b>1114</b>
Audi 80, 90 & Coupe Petrol (Oct 86 - 90) D to H	<b>1491</b>	Ford Escort Mk I 1100 & 1300 (68 - 74) up to N *	<b>0171</b>	Mercedes-Benz 250 & 280 (68 - 72) up to L *	<b>0346</b>
Audi 100 & 200 Petrol (Oct 82 - 90) up to H	<b>0907</b>	Ford Escort Mk I Mexico, RS 1600 & RS 2000 (70 - 74) up to N *	<b>0139</b>	Mercedes-Benz 250 & 280 123 Series Petrol (Oct 76 - 84) up to B *	<b>0677</b>
Audi 100 & A6 Petrol & Diesel (May 91 - May 97) H to P	<b>3504</b>	Ford Escort Mk II Mexico, RS 1800 & RS 2000 (75 - 80) up to W *	<b>0735</b>	Mercedes-Benz 124 Series Petrol & Diesel (85 - Aug 93) C to K	<b>3253</b>
Audi A3 Petrol & Diesel (96 - May 03) P to O3	<b>4253</b>	Ford Escort (75 - Aug 80) up to V *	<b>0280</b>	Mercedes-Benz C-Class Petrol & Diesel (93 - Aug 00) L to W	<b>3511</b>
Audi A4 Petrol & Diesel (95 - Feb 00) M to V	<b>3575</b>	Ford Escort Petrol (Sept 80 - Sept 90) up to H	<b>0686</b>	<b>MGA</b> (55 - 62) *	<b>0475</b>
<b>AUSTIN</b> A35 & A40 (56 - 67) up to F *	<b>0118</b>	Ford Escort & Orion Petrol (Sept 90 - 00) H to X	<b>1737</b>	MGB (62 - 80) up to W	<b>0111</b>
Austin/MG/Rover Maestro 1.3 & 1.6 Petrol (83 - 95) up to M	<b>0922</b>	Ford Escort & Orion Diesel (Sept 90 - 00) H to X	<b>4081</b>	MG Midget & Austin-Healey Sprite (58 - 80) up to W *	<b>0265</b>
Austin/MG Metro (80 - May 90) up to G	<b>0718</b>	Ford Fiesta (76 - Aug 83) up to Y	<b>0334</b>	<b>MINI</b> Petrol (July 01 - 05) Y to O5	<b>4273</b>
Austin/Rover Montego 1.3 & 1.6 Petrol (84 - 94) A to L	<b>1066</b>	Ford Fiesta Petrol (Aug 83 - Feb 89) A to F	<b>1030</b>	<b>MITSUBISHI</b> Shogun & L200 Pick-Ups Petrol (83 - 94) up to M	<b>1944</b>
Austin/MG/Rover Montego 2.0 Petrol (84 - 95) A to M	<b>1067</b>	Ford Fiesta Petrol (Feb 89 - Oct 95) F to N	<b>1595</b>	<b>MORRIS</b> Ital 1.3 (80 - 84) up to B	<b>0705</b>
Mini (59 - 69) up to H *	<b>0527</b>	Ford Fiesta Petrol & Diesel (Oct 95 - Mar 02) N to O2	<b>3397</b>	Morris Minor 1000 (56 - 71) up to K	<b>0024</b>
Mini (69 - 01) up to X	<b>0646</b>	Ford Fiesta Petrol & Diesel (Apr 02 - 05) O2 to 54	<b>4170</b>	<b>NISSAN</b> Almera Petrol (95 - Feb 00) N to V	<b>4053</b>
Austin/Rover 2.0 litre Diesel Engine (86 - 93) C to L	<b>1857</b>	Ford Focus Petrol & Diesel (98 - 01) S to Y	<b>3759</b>	Nissan Bluebird (May 84 - Mar 86) A to C	<b>1223</b>
Austin Healey 100/6 & 3000 (56 - 68) up to G *	<b>0049</b>	Ford Focus Petrol & Diesel (Oct 01 - 04) 51 to 54	<b>4167</b>	Nissan Bluebird Petrol (Mar 86 - 90) C to H	<b>1473</b>
<b>BEDFORD</b> CF Petrol (69 - 87) up to E	<b>0163</b>	Ford Galaxy Petrol & Diesel (95 - Aug 00) M to W	<b>3984</b>	Nissan Cherry (Sept 82 - 86) up to D	<b>1031</b>
Bedford/Vauxhall Rascal & Suzuki Supercarry (86 - Oct 94) C to M	<b>3015</b>	Ford Granada Petrol (Sept 77 - Feb 85) up to B *	<b>0481</b>	Nissan Micra (83 - Jan 93) up to K	<b>0931</b>
<b>BMW</b> 316, 320 & 320i (4-cyl) (75 - Feb 83) up to Y *	<b>0276</b>	Ford Granada & Scorpio Petrol (Mar 85 - 94) B to M	<b>1245</b>	Nissan Micra (93 - 02) K to 52	<b>3254</b>
BMW 320, 320i, 323i & 325i (6-cyl) (Oct 77 - Sept 87) up to E	<b>0815</b>	Ford Ka (96 - 02) P to 52	<b>3570</b>	Nissan Primera Petrol (90 - Aug 99) H to T	<b>1851</b>
BMW 3- & 5-Series Petrol (81 - 91) up to J	<b>1948</b>	Ford Mondeo Petrol (93 - Sept 00) K to X	<b>1923</b>	Nissan Stanza (82 - 86) up to D	<b>0824</b>
BMW 3-Series Petrol (Apr 91 - 96) H to N	<b>3210</b>	Ford Mondeo Petrol & Diesel (Oct 00 - Jul 03) X to O3	<b>3990</b>	Nissan Sunny Petrol (May 82 - Oct 86) up to D	<b>0895</b>
BMW 3-Series Petrol (Sept 98 - 03) S to 53	<b>4067</b>	Ford Mondeo Diesel (93 - 96) L to N	<b>3465</b>	Nissan Sunny Petrol (Oct 86 - Mar 91) D to H	<b>1378</b>
BMW 520i & 525e (Oct 81 - June 88) up to E	<b>1560</b>	Ford Orion Petrol (83 - Sept 90) up to H	<b>1009</b>	Nissan Sunny Petrol (Apr 91 - 95) H to N	<b>3219</b>
BMW 525, 528 & 528i (73 - Sept 81) up to X *	<b>0632</b>	Ford Sierra 4-cyl Petrol (82 - 93) up to K	<b>0903</b>	<b>OPEL</b> Ascona & Manta (B Series) (Sept 75 - 88) up to F *	<b>0316</b>
BMW 5-Series 6-cyl Petrol (April 96 - Aug 03) N to O3	<b>4151</b>	Ford Sierra V6 Petrol (82 - 91) up to J	<b>0904</b>	Opel Ascona Petrol (81 - 88)	<b>3215</b>
BMW 1500, 1502, 1600, 1602, 2000 & 2002 (59 - 77) up to S *	<b>0240</b>	Ford Transit Petrol (Mk 2) (78 - Jan 86) up to C	<b>0719</b>	Opel Astra Petrol (Oct 91 - Feb 98)	<b>3156</b>
<b>CHRYSLER</b> PT Cruiser Petrol (00 - 03) W to 53	<b>4058</b>	Ford Transit Petrol (Mk 3) (Feb 86 - 89) C to G	<b>1468</b>	Opel Corsa Petrol (83 - Mar 93)	<b>3160</b>
<b>CITROËN</b> 2CV, Ami & Dyane (67 - 90) up to H	<b>0196</b>	Ford Transit Diesel (Feb 86 - 99) C to T	<b>3019</b>	Opel Corsa Petrol (Mar 93 - 97)	<b>3159</b>
Citroën AX Petrol & Diesel (87 - 97) D to P	<b>3014</b>	Ford 1.6 & 1.8 litre Diesel Engine (84 - 96) A to N	<b>1172</b>	Opel Kadett Petrol (Nov 79 - Oct 84) up to B	<b>0634</b>
Citroën Berlingo & Peugeot Partner Petrol & Diesel (96 - 05) P to 55	<b>4281</b>	Ford 2.1, 2.3 & 2.5 litre Diesel Engine (77 - 90) up to H	<b>1606</b>	Opel Kadett Petrol (Oct 84 - Oct 91)	<b>3196</b>
Citroën BX Petrol (83 - 94) A to L	<b>0908</b>	<b>FREIGHT ROVER</b> Sherpa Petrol (74 - 87) up to E	<b>0463</b>	Opel Omega & Senator Petrol (Nov 86 - 94)	<b>3157</b>
Citroën C15 Van Petrol & Diesel (89 - Oct 98) F to S	<b>3509</b>	<b>HILLMAN</b> Avenger (70 - 82) up to Y	<b>0037</b>	Opel Rekord Petrol (Feb 78 - Oct 86) up to D	<b>0543</b>
Citroën C3 Petrol & Diesel (02 - 05) 51 to 05	<b>4197</b>	Hillman Imp (63 - 76) up to R *	<b>0022</b>	Opel Vectra Petrol (Oct 88 - Oct 95)	<b>3158</b>
Citroën CX Petrol (75 - 88) up to F	<b>0528</b>	<b>HONDA</b> Civic (Feb 84 - Oct 87) A to E	<b>1226</b>	<b>PEUGEOT</b> 106 Petrol & Diesel (91 - 04) J to 53	<b>1882</b>
Citroën Saxo Petrol & Diesel (96 - 04) N to 54	<b>3506</b>	Honda Civic (Nov 91 - 96) J to N	<b>3199</b>	Peugeot 205 Petrol (83 - 97) A to P	<b>0932</b>
Citroën Visa Petrol (79 - 88) up to F	<b>0620</b>	Honda Civic Petrol (Mar 95 - 00) M to X	<b>4050</b>	Peugeot 206 Petrol & Diesel (98 - 01) S to X	<b>3757</b>
Citroën Xantia Petrol & Diesel (93 - 01) K to Y	<b>3082</b>	<b>HYUNDAI</b> Pony (85 - 94) C to M	<b>3398</b>	Peugeot 306 Petrol & Diesel (93 - 02) K to O2	<b>3073</b>
Citroën XM Petrol & Diesel (89 - 00) G to X	<b>3451</b>	<b>JAGUAR</b> E Type (61 - 72) up to L *	<b>0140</b>	Peugeot 307 Petrol & Diesel (01 - 04) Y to 54	<b>4147</b>
Citroën Xsara Petrol & Diesel (97 - Sept 00) R to W	<b>3751</b>	Jaguar MkI & II, 240 & 340 (55 - 69) up to H *	<b>0098</b>	Peugeot 309 Petrol (86 - 93) C to K	<b>1266</b>
Citroën Xsara Picasso Petrol & Diesel (00 - 02) W to 52	<b>3944</b>	Jaguar XJ6, XJ & Sovereign; Daimler Sovereign (68 - Oct 86) up to D	<b>0242</b>	Peugeot 405 Petrol (88 - 97) E to P	<b>1559</b>
Citroën ZX Diesel (91 - 98) J to S	<b>1922</b>	Jaguar XJ6 & Sovereign (Oct 86 - Sept 94) D to M	<b>3261</b>	Peugeot 405 Diesel (88 - 97) E to P	<b>3198</b>
Citroën ZX Petrol (91 - 98) H to S	<b>1881</b>	Jaguar XJ12, XJS & Sovereign; Daimler Double Six (72 - 88) up to F	<b>0478</b>	Peugeot 406 Petrol & Diesel (96 - Mar 99) N to T	<b>3394</b>
Citroën 1.7 & 1.9 litre Diesel Engine (84 - 96) A to N	<b>1379</b>	<b>JEEP</b> Cherokee Petrol (93 - 96) K to N	<b>1943</b>	Peugeot 406 Petrol & Diesel (Mar 99 - 02) T to 52	<b>3982</b>
<b>FIAT</b> 126 (73 - 87) up to E *	<b>0305</b>	<b>LADA</b> 1200, 1300, 1500 & 1600 (74 - 91) up to J	<b>0413</b>	Peugeot 505 Petrol (79 - 89) up to G	<b>0762</b>
Fiat 500 (57 - 73) up to M *	<b>0090</b>	Lada Samara (87 - 91) D to J	<b>1610</b>	Peugeot 1.7/1.8 & 1.9 litre Diesel Engine (82 - 96) up to N	<b>0950</b>
Fiat Bravo & Brava Petrol (95 - 00) N to W	<b>3572</b>	<b>LAND ROVER</b> 90, 110 & Defender Diesel (83 - 95) up to N	<b>3017</b>	Peugeot 2.0, 2.1, 2.3 & 2.5 litre Diesel Engines (74 - 90) up to H	<b>1607</b>
Fiat Cinquecento (93 - 98) K to R	<b>3501</b>	Land Rover Discovery Petrol & Diesel (89 - 98) G to S	<b>3016</b>	<b>PORSCHE</b> 911 (65 - 85) up to C	<b>0264</b>
Fiat Panda (81 - 95) up to M	<b>0793</b>	Land Rover Freelander Petrol & Diesel (97 - 02) R to 52	<b>3929</b>	Porsche 924 & 924 Turbo (76 - 85) up to C	<b>0397</b>
Fiat Punto Petrol & Diesel (94 - Oct 99) L to V	<b>3251</b>	Land Rover Series IIA & III Diesel (58 - 85) up to C	<b>0529</b>	<b>PROTON</b> (89 - 97) F to P	<b>3255</b>
Fiat Punto Petrol (Oct 99 - July 03) V to O3	<b>4066</b>	Land Rover Series II, IIA & III 4-cyl Petrol (58 - 85) up to C	<b>0314</b>	<b>RANGE ROVER</b> V8 Petrol (70 - Oct 92) up to K	<b>0606</b>
Fiat Regata Petrol (84 - 88) A to F	<b>1167</b>	<b>MAZDA</b> 323 (Mar 81 - Oct 89) up to G	<b>1608</b>	<b>RELIANT</b> Robin & Kitten (73 - 83) up to A *	<b>0436</b>
Fiat Tipo Petrol (88 - 91) E to J	<b>1625</b>	Mazda 323 (Oct 89 - 98) G to R	<b>3455</b>	<b>RENAULT</b> 4 (61 - 86) up to D *	<b>0072</b>
Fiat Uno Petrol (83 - 95) up to M	<b>0923</b>	Mazda 626 (May 83 - Sept 87) up to E	<b>0929</b>		
Fiat X1/9 (74 - 89) up to G *	<b>0273</b>	Mazda B1600, B1800 & B2000 Pick-up Petrol (72 - 88) up to F	<b>0267</b>		

\* Classic reprint

Title	Book No.
Renault 5 Petrol (Feb 85 - 96) B to N	1219
Renault 9 & 11 Petrol (82 - 89) up to F	0822
Renault 18 Petrol (79 - 86) up to D	0598
Renault 19 Petrol (89 - 96) F to N	1646
Renault 19 Diesel (89 - 96) F to N	1946
Renault 21 Petrol (86 - 94) C to M	1397
Renault 25 Petrol & Diesel (84 - 92) B to K	1228
Renault Clio Petrol (91 - May 98) H to R	1853
Renault Clio Diesel (91 - June 96) H to N	3031
Renault Clio Petrol & Diesel (May 98 - May 01) R to Y	3906
Renault Clio Petrol & Diesel (June 01 - 04) Y to 54	4168
Renault Espace Petrol & Diesel (85 - 96) C to N	3197
Renault Laguna Petrol & Diesel (94 - 00) L to W	3252
Renault Laguna Petrol & Diesel (01 - 05) X to 05	4283
Renault Mègane & Scénic Petrol & Diesel (96 - 98) N to R	3395
Renault Mègane & Scénic Petrol & Diesel (Apr 99 - 02) T to 52	3916
Renault Megane Petrol & Diesel (Oct 02 - 05) 52 to 55	4284
Renault Scenic Petrol & Diesel (Sept 03 - 06) 53 to 06	4297
ROVER 213 & 216 (84 - 89) A to G	1116
Rover 214 & 414 Petrol (89 - 96) G to N	1689
Rover 216 & 416 Petrol (89 - 96) G to N	1830
Rover 211, 214, 216, 218 & 220 Petrol & Diesel (Dec 95 - 99) N to V	3399
Rover 25 & MG ZR Petrol & Diesel (Oct 99 - 04) V to 54	4145
Rover 414, 416 & 420 Petrol & Diesel (May 95 - 98) M to R	3453
Rover 45 / MG ZS	4384
Rover 618, 620 & 623 Petrol (93 - 97) K to P	3257
Rover 75 / MG ZT Petrol & Diesel (Feb 99 - 05) T to 05	4292
Rover 820, 825 & 827 Petrol (86 - 95) D to N	1380
Rover 3500 (76 - 87) up to E *	0365
Rover Metro, 111 & 114 Petrol (May 90 - 98) G to S	1711
SAAB 95 & 96 (66 - 76) up to R *	0198
Saab 90, 99 & 900 (79 - Oct 93) up to L	0765
Saab 900 (Oct 93 - 98) L to R	3512
Saab 9000 (4-cyl) (85 - 98) C to S	1686
Saab 9-5 4-cyl Petrol (97 - 04) R to 54	4156
SEAT Ibiza & Cordoba Petrol & Diesel (Oct 93 - Oct 99) L to V	3571
Seat Ibiza & Malaga Petrol (85 - 92) B to K	1609
SKODA Estelle (77 - 89) up to G	0604
Skoda Fabia (00 - 06) W to 06	4376
Skoda Favorit (89 - 96) F to N	1801
Skoda Felicia Petrol & Diesel (95 - 01) M to X	3505
Skoda Octavia Petrol & Diesel (98 - Apr 04) R to 04	4285
SUBARU 1600 & 1800 (Nov 79 - 90) up to H *	0995
SUNBEAM Alpine, Rapier & H120 (67 - 74) up to N *	0051
SUZUKI SJ Series, Samurai & Vitara (4-cyl) Petrol (82 - 97) up to P	1942
Suzuki Supercarry & Bedford/Vauxhall Rascal (86 - Oct 94) C to M	3015
TALBOT Alpine, Solara, Minx & Rapier (75 - 86) up to D	0337
Talbot Horizon Petrol (78 - 86) up to D	0473
Talbot Samba (82 - 86) up to D	0823
TOYOTA Avensis Petrol (Nov 97 - Jan 03) R to 52	4264
Toyota Carina E Petrol (May 92 - 97) J to P	3256
Toyota Corolla (80 - 85) up to C	0683

Title	Book No.
Toyota Corolla (Sept 83 - Sept 87) A to E	1024
Toyota Corolla (Sept 87 - Aug 92) E to K	1683
Toyota Corolla Petrol (Aug 92 - 97) K to P	3259
Toyota Corolla Petrol (June 97 - 01) P to 51	4286
Toyota Hi-Ace & Hi-Lux Petrol (69 - Oct 83) up to A	0304
Toyota Yaris Petrol (99 - 05) T to 05	4265
TRIUMPH GT6 & Vitesse (62 - 74) up to N *	0112
Triumph Herald (59 - 71) up to K *	0010
Triumph Spitfire (62 - 81) up to X	0113
Triumph Stag (70 - 78) up to T *	0441
Triumph TR2, TR3, TR3A, TR4 & TR4A (52 - 67) up to F *	0028
Triumph TR5 & 6 (67 - 75) up to P *	0031
Triumph TR7 (75 - 82) up to Y *	0322
VAUXHALL Astra Petrol (80 - Oct 84) up to B	0635
Vauxhall Astra & Belmont Petrol (Oct 84 - Oct 91) B to J	1136
Vauxhall Astra Petrol (Oct 91 - Feb 98) J to R	1832
Vauxhall/Opel Astra & Zafira Petrol (Feb 98 - Apr 04) R to 04	3758
Vauxhall/Opel Astra & Zafira Diesel (Feb 98 - Apr 04) R to 04	3797
Vauxhall/Opel Calibra (90 - 98) G to S	3502
Vauxhall Carlton Petrol (Oct 78 - Oct 86) up to D	0480
Vauxhall Carlton & Senator Petrol (Nov 86 - 94) D to L	1469
Vauxhall Cavalier Petrol (81 - Oct 88) up to F	0812
Vauxhall Cavalier Petrol (Oct 88 - 95) F to N	1570
Vauxhall Chevette (75 - 84) up to B	0285
Vauxhall/Opel Corsa Diesel (Mar 93 - Oct 00) K to X	4087
Vauxhall Corsa Petrol (Mar 93 - 97) K to R	1985
Vauxhall/Opel Corsa Petrol (Apr 97 - Oct 00) P to X	3921
Vauxhall/Opel Corsa Petrol & Diesel (Oct 00 - Sept 03) X to 53	4079
Vauxhall/Opel Frontera Petrol & Diesel (91 - Sept 98) J to S	3454
Vauxhall Nova Petrol (83 - 93) up to K	0909
Vauxhall/Opel Omega Petrol (94 - 99) L to T	3510
Vauxhall/Opel Vectra Petrol & Diesel (95 - Feb 99) N to S	3396
Vauxhall/Opel Vectra Petrol & Diesel (Mar 99 - May 02) T to 02	3930
Vauxhall/Opel 1.5, 1.6 & 1.7 litre Diesel Engine (82 - 96) up to N	1222
VOLKSWAGEN 411 & 412 (68 - 75) up to P *	0091
Volkswagen Beetle 1200 (54 - 77) up to S	0036
Volkswagen Beetle 1300 & 1500 (65 - 75) up to P	0039
Volkswagen Beetle 1302 & 1302S (70 - 72) up to L *	0110
Volkswagen Beetle 1303, 1303S & GT (72 - 75) up to P	0159
Volkswagen Beetle Petrol & Diesel (Apr 99 - 01) T to 51	3798
Volkswagen Golf & Jetta Mk 1 Petrol 1.1 & 1.3 (74 - 84) up to A	0716
Volkswagen Golf, Jetta & Scirocco Mk 1 Petrol 1.5, 1.6 & 1.8 (74 - 84) up to A	0726
Volkswagen Golf & Jetta Mk 1 Diesel (78 - 84) up to A	0451
Volkswagen Golf & Jetta Mk 2 Petrol (Mar 84 - Feb 92) A to J	1081
Volkswagen Golf & Vento Petrol & Diesel (Feb 92 - Mar 98) J to R	3097
Volkswagen Golf & Bora Petrol & Diesel (April 98 - 00) R to X	3727
Volkswagen Golf & Bora 4-cyl Petrol & Diesel (01 - 03) X to 53	4169

Title	Book No.
Volkswagen LT Petrol Vans & Light Trucks (76 - 87) up to E	0637
Volkswagen Passat & Santana Petrol (Sept 81 - May 88) up to E	0814
Volkswagen Passat 4-cyl Petrol & Diesel (May 88 - 96) E to P	3498
Volkswagen Passat 4-cyl Petrol & Diesel (Dec 96 - Nov 00) P to X	3917
Volkswagen Passat Petrol & Diesel (Dec 00 - May 05) X to 05	4279
Volkswagen Polo & Derby (76 - Jan 82) up to X	0335
Volkswagen Polo (82 - Oct 90) up to H	0813
Volkswagen Polo Petrol (Nov 90 - Aug 94) H to L	3245
Volkswagen Polo Hatchback Petrol & Diesel (94 - 99) M to S	3500
Volkswagen Polo Hatchback Petrol (00 - Jan 02) V to 51	4150
Volkswagen Scirocco (82 - 90) up to H *	1224
Volkswagen Transporter 1600 (68 - 79) up to V	0082
Volkswagen Transporter 1700, 1800 & 2000 (72 - 79) up to V *	0226
Volkswagen Transporter (air-cooled) Petrol (79 - 82) up to Y *	0638
Volkswagen Transporter (water-cooled) Petrol (82 - 90) up to H	3452
Volkswagen Type 3 (63 - 73) up to M *	0084
VOLVO 120 & 130 Series (& P1800) (61 - 73) up to M *	0203
Volvo 142, 144 & 145 (66 - 74) up to N *	0129
Volvo 240 Series Petrol (74 - 93) up to K	0270
Volvo 262, 264 & 260/265 (75 - 85) up to C *	0400
Volvo 340, 343, 345 & 360 (76 - 91) up to J	0715
Volvo 440, 460 & 480 Petrol (87 - 97) D to P	1691
Volvo 740 & 760 Petrol (82 - 91) up to J	1258
Volvo 850 Petrol (92 - 96) J to P	3260
Volvo 940 Petrol (90 - 96) H to N	3249
Volvo S40 & V40 Petrol (96 - Mar 04) N to 04	3569
Volvo S70, V70 & C70 Petrol (96 - 99) P to V	3573
Volvo V70 / S80 Petrol & Diesel (98 - 05) S to 55	4263

#### AUTOMOTIVE TECHBOOKS

Automotive Air Conditioning Systems	3740
Automotive Electrical and Electronic Systems Manual	3049
Automotive Gearbox Overhaul Manual	3473
Automotive Service Summaries Manual	3475
Automotive Timing Belts Manual - Austin/Rover	3549
Automotive Timing Belts Manual - Ford	3474
Automotive Timing Belts Manual - Peugeot/Citroën	3568
Automotive Timing Belts Manual - Vauxhall/Opel	3577

#### DIY MANUAL SERIES

The Haynes Air Conditioning Manual	4192
The Haynes Manual on Bodywork	4198
The Haynes Manual on Brakes	4178
The Haynes Manual on Carburettors	4177
The Haynes Car Electrical Systems Manual	4251
The Haynes Manual on Diesel Engines	4174
The Haynes Manual on Engine Management	4199
The Haynes Manual on Fault Codes	4175
The Haynes Manual on Practical Electrical Systems	4267
The Haynes Manual on Small Engines	4250
The Haynes Manual on Welding	4176

\* Classic reprint

All the products featured on this page are available through most motor accessory shops, cycle shops and book stores. Our policy of continuous updating and development means that titles are being constantly added to the range. For up-to-date information on our complete list of titles, please telephone: (UK) +44 1963 442030 • (USA) +1 805 498 6703 • (France) +33 1 47 17 66 29 • (Sweden) +46 18 124016 • (Australia) +61 3 9763 8100